

Key and Plug Assemblies

An overview..

By Chris Bisailion VE₃CBK and Louis Meulstee PA_oPCR



Key and Plug Assemblies were essential parts of most British (and Commonwealth) Army radio stations. This overview shows the currently known types and versions of these Morse key assemblies, spanning the period of the late 1930s until the 1950s when the Larkspur range of equipment started coming into service.

Cover and layout: Louis Meulstee PA0PCR.
Cover illustration: Key and Plug Assembly No. 19.

The cover artwork and layout of this overview was prepared in Serif PagePlus X6 using Arial and Formal 436 BT fonts. The scanned illustrations and photos were enhanced and prepared with the use of Adobe Photoshop. The finished publication was directly converted into PDF format.

Version 1.03 June 2014
First published 2014
© Louis Meulstee PA0PCR
Ottersum
The Netherlands
info@wftw.nl
<http://www.wftw.nl>

About this publication.

Key and Plug Assemblies were essential parts of most British (and Commonwealth) Army wireless sets and stations. This overview shows the currently known types and versions of these Morse key assemblies, spanning the period from the late 1930s until the 1950s when the Larkspur range of equipment started coming into service. This publication is a follow-up of '*Lamps, Operator An overview..*'. It was compiled in close collaboration with Chris Bisailion VE3CBK. Many of the keys in this overview are from Chris' collection.

Newly found material may be included in later versions of this publication. This will be announced in the '*What's New*' and '*Downloads*' page on my website <http://www.wftw.nl>
If you have any comments, or would like to suggest any additions or amendments please contact the author by email on louis@wftw.nl

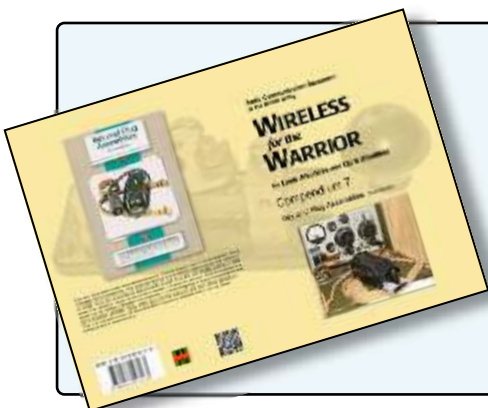

No colour printer available or considering that the printing costs of 54 colour pages is excessively high? Or looking for an original and nice present for a Morse key enthusiast?

In preparation is a modestly priced, professionally full colour printed and bound copy of this overview in A5 format matching the WftW Compendium series.

Progress and availability of this project will be notified on my website <http://www.wftw.nl/whatsnew.html>



June 2014

Introduction

Morse keys issued with British Army wireless sets intended to be used under field conditions were often provided with a metal protective cover. It protected the operator from coming into contact with high potential, and the key from dust and rough handling. This pattern of key, mounted on an assembly base plate with protective cover, complete with a lead and plug and usually fitted with canvas knee straps, was designated 'Key and Plug Assembly'.

Key and plug assemblies were essential parts of many British (and Commonwealth) Army field wireless sets and stations. This overview shows the currently known types of these Morse key assemblies (versions with and without protective cover, and knee straps), spanning the period from the late 1930s until the early 1950s when the Larkspur range of equipment started coming into service.

It should be emphasised that nearly any design, version and variation of the British Army Key W.T. 8 Amp can be found fitted in the British manufactured key and plug assemblies, particularly the No. 8 and No. 9 assemblies. It was therefore virtually impossible to classify a key and plug assembly version just by its Morse key. The Canadian- and US-produced assemblies, however, had an exclusive key for each classified version. The only common feature of all British designs, versions and variations of the Key W.T. 8 Amp, and those produced abroad, were the dimensions of the key base and positions of the mounting holes.

As already pointed out by Chris Bisailion in his 1996 article '*Keys for Wireless Set No. 19 (Canada and USA)*', most of the later versions and variants of the Key W.T. 8 Amp were a direct result of wartime material shortage and pressure on production capacity. For example the Key W.T. 8 Amp No. 2 was downgraded from a massive brass construction which was complicated to produce and requiring much raw material, to the Key W.T. 8 Amp No. 2 Mk.III made from Bakelite moulding which was considerably cheaper and easier to produce.

This overview includes the Key and Plug Assembly No. 7, believed to be used with Wireless Set No. 28. No firm confirmation of its nomenclature was found and surviving examples of this assembly could not be traced. Apart from a mention in the station list no further data has been found of Key and Plug Assembly No. 133 (Aust). It is therefore only noted in the Key and Plug Overview List on the next page.

During the compilation of this overview it became clear that several Key and Plug Assemblies No. 9 had only minor differences which made it difficult to decide whether to include just small production differences. As a compromise only the more obvious and common versions were listed.

Version (classification) numbers, printed in red, are included as a guide to identify the variations of Key and Plug Assemblies Nos. 8 and 9. As a further guide the two basic designs of British Key W.T. 8 Amp with their principal versions are listed in Appendix 2. No attempt has been made to include the many variations or the keys of this pattern produced abroad.

Exploded view drawings, originally published in Canadian EMERs were added at a later stage during the preparation of this overview in Appendix 3, along with a facsimile page of the original design of the Key W.T. 8 Amp dating back to 1924 in Appendix 1.

The explanatory text in this overview was kept to the minimum as it was considered that a single illustration usually tells more than an extensive and long winded description. Although consistently named 'finger rest', the round plate under the key knob was also known as 'guard'. Definitions of the most common items of key and plug assemblies are given in Appendix 5.

Acknowledgements:

Thanks are due to **Tony Bell** VK5UA, Australia; **Brent Bevan** ZL2FFR, New Zealand; **Chris Jones** G8GFB, U.K.; **Ron McMullen**, Australia; **Mike Prince** GW7EUL, U.K.; **Keith Watt** G4MSF, U.K. and **Mike Willenbroek**, Holland. Without their assistance, proof reading, encouragement and generous contributions in the form of photographs, this overview could not have been so complete.

Abbreviations used in this overview:

V.A.O.S. = Vocabulary of Army Ordnance Stores

N.I.V. = Not In Vocabulary

I.C.W. = Interrupted Continuous Wave

E.M.E.R.s = Electrical and Mechanical Engineering Regulations

DAD = Department of Defence (Australia)

A.A. = Anti Aircraft

W.T. = Wireless Telegraphy

Assembly type number and version	V.A.O.S.	Used with set/system	Page
Key and Plug Assembly No. 1		Wireless Set No. 2.	5
Key and Plug Assembly No. 2		Wireless Set No. 2.	5
Key and Plug Assembly No. 2B	ZA 4500	Wireless Sets Nos. 11,12, 22, 33 etc.	6
Key and Plug Assembly No. 2B (Aust)	ZA 4500	W'less Sets Nos. 11 (Aust),108 Mk.III, 208.	7
Key and Plug Assembly No. 2B (Can)		Wireless Set No. 11 (Cdn).	8
Key and Plug Assembly No. 2B (N.Z.)	GA200	Wireless Set ZC1 Mk.I and Mk.II.	9
Key and Plug Assembly No. 2C	ZA 4482	Wireless Set No. 11 in A11 tank etc.	10
Key and Plug Assembly No. 2D	ZA 14306	W'less Sets Nos. 12 HP, 33, 53, H.S.1, etc.	10
Key and Plug Assembly No. 2E		RCUs G No. 2 and H No. 2.	10
Key and Plug Assembly No. 4		Wireless Set No. 3 vehicle station.	11
Key and Plug Assembly No. 5		Wireless Set No. 3 ground station.	11
Key and Plug Assembly No. 6	ZA 8328	Wireless Sets Nos. 9, 9 (Can), 36.	12
Key and Plug Assembly No. 7		Wireless Set No. 28 (Not yet confirmed).	13
Key and Plug Assembly No. 8 (Ver. 1)	ZA 4354	Wireless Sets Nos. 18, 68.	14
Key and Plug Assembly No. 8 (Ver. 2)	ZA 4354	Wireless Sets Nos. 18, 68.	15
Key and Plug Assembly No. 8A	ZA/US/1104	Wireless Set No. 48.	17
Key and Plug Assembly No. 8B	ZA 24790	Wireless Sets Nos. 18T, 68T.	18
<hr/>			
Key and Plug Assembly No. 9 (England)			
Key and Plug Assembly No. 9 (Ver. 1)	ZA 0937	Wireless Set No. 19 All versions.	19
Key and Plug Assembly No. 9 (Ver. 2)	ZA 0937	Wireless Set No. 19 All versions.	20
Key and Plug Assembly No. 9 (Ver. 3.1)	ZA 0937	Wireless Set No. 19 All versions.	21
Key and Plug Assembly No. 9 (Ver. 3.2)	ZA 0937	Wireless Set No. 19 All versions.	22
Key and Plug Assembly No. 9 (Ver. 3.3)	ZA 0937	Wireless Set No. 19 All versions.	23
Key and Plug Assembly No. 9A (Ver. 4.1)	ZA 17693	Wireless Set No. 76.	24
Key and Plug Assembly No. 9AT (Ver. 4.2)	ZA 29115	Wireless Set No. 76T.	25
Key and Plug Assembly No. 9 Mk.1/1 (Ver. 4.3)	ZA 26291	Wireless Set No. 19 Tropicalised.	26
Key and Plug Assembly No. 9 (Ver. 4.4)		Wireless Set Special type 6X1.	27
Key and Plug Assembly No. 9 (Canada)			
Key and Plug Assembly No. 9 (Ver. 5)	ZA/CAN/BR 0937	Wireless Sets Nos. 9 Mk.I,19 Mk.II (Can).	28
Key and Plug Assembly No. 9 Type 1 (Ver. 6)	ZA/CAN 1643	Wireless Set No. 19 Mk.II and Mk.III (Can).	29
Key and Plug Assembly No. 9 Type 2 (Ver. 7)	ZA/CAN 0715	W'less Sets Nos. 19 Mk.III (Can), 52 (Can).	30
Key and Plug Assembly No. 9 Type 2/T (Ver. 8)	ZA/CAN 2320	Wireless Set No. 29 (Can).	31
Key and Plug Assembly No. 9 (USA/Aust)			
Key and Plug Assembly No. 9 (Ver. 9.1)		Wireless Set No. 19 USA manufacture.	32
Key and Plug Assembly No. 9 (Ver. 9.2)		Wireless Set No. 19 USA manufacture.	33
Key and Plug Assembly No. 9 (Ver. 9.3)		Wireless Set No. 19 USA manufacture.	34
Key and Plug Assembly No. 9 (Ver. 10.1)		Wireless Set No. 19 USA manufacture.	35
Key and Plug Assembly No. 9 (Ver. 10.2)		Wireless Set No. 19 USA manufacture.	36
Key and Plug Assembly No. 9 (Ver. 11)	ZA 0937	Wireless Sets Nos. 19, 22, 122 (Aust).	37
<hr/>			
Key and Plug Assembly No. 17	ZA 25381	Wireless Set No. 42.	38
Key and Plug Assembly No. 18		S.P.F. Mk.2.	38
Key and Plug Assembly No. 19	ZA 28656	Wireless Set No. 62 and SR C12.	39
Keys WT complete with cord and plug	N.I.V.	Wireless Set No. 43 (Can).	40
RCU H (Aust), Key, Plug and Plate Assembly	ZAA1120/1121	Wireless Set No. 153.	41
Type 3R2018 Morse Key (AWA)		Teleradio 3BZ and AMC 145.	42
Type B50410 Hand Key (AWA)		Australian AMT-150 (TW-12).	42
Key and Plug Assembly No. 133 (Aust)	ZAA 4317	Wireless Set No. 133.	—

Key and Plug Assembly Overview. List of type numbers and versions.

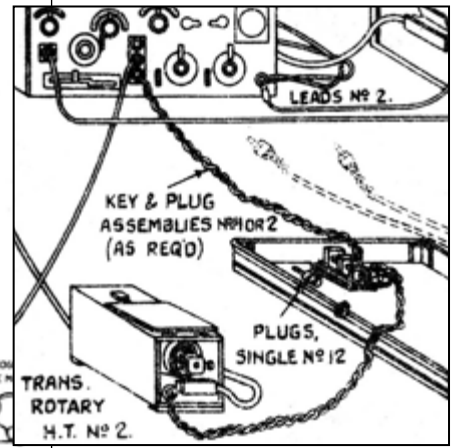
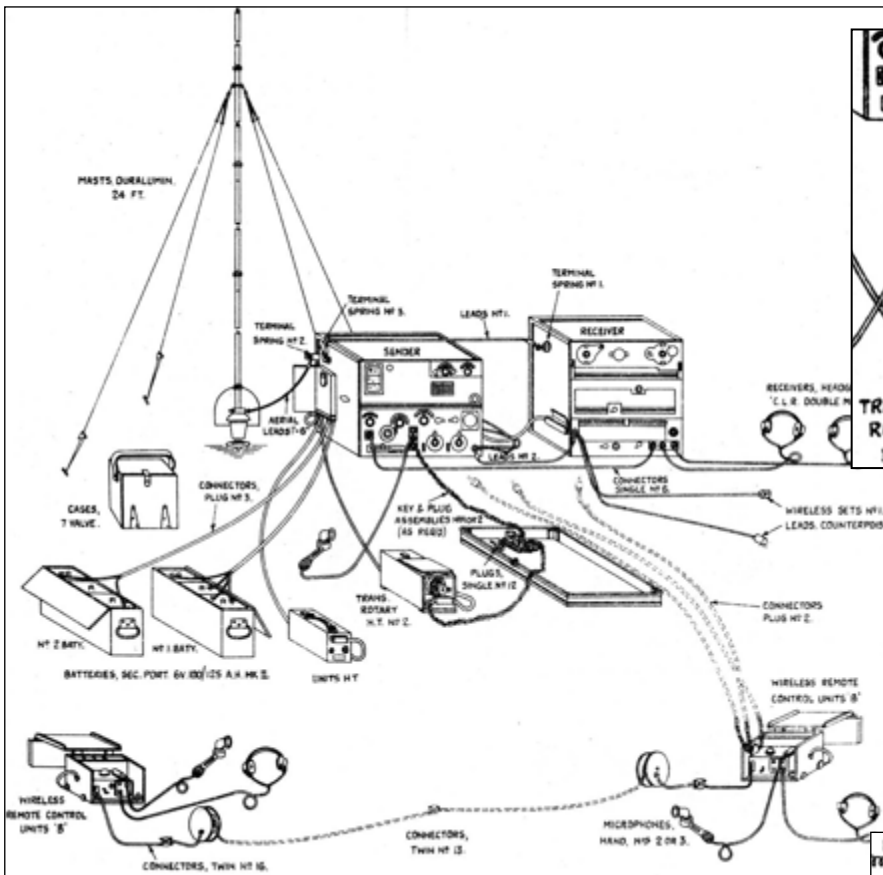

Wireless Set No. 2 set-up as a ground station. The enlarged section above shows how the Key and Plug Assembly No. 1 or No. 2 was connected to the set and rotary transformer.

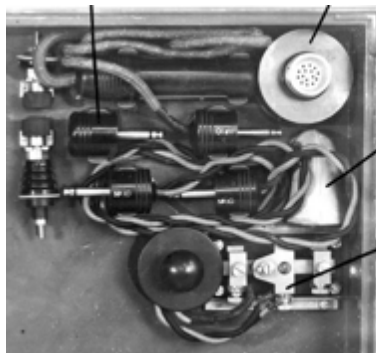

MICROPHONE MOUTHPIECE.

KEY (WITH TWO LEADS AND TWO PLUGS SINGLE NO. 10)

Interior view of No. 2 Set sender lid (above). The Key and Plug Assembly No. 1 or 2 (with a Key W.T. 8 Amp No. 2) was normally stowed in this position when not required.

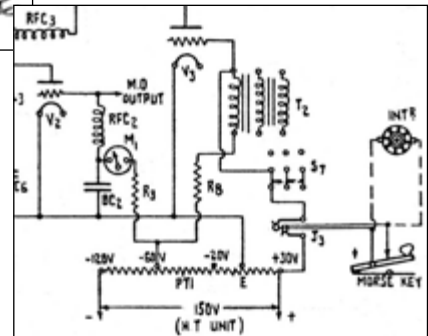

Part of circuit diagram Wireless Sender No. 2 showing the keying circuits and connections to the interruptor for I.C.W. keying (above).



Wireless Set No. 2 was a transmitter-receiver for mobile or ground operation, developed in 1934. This set was only made in small numbers. Use: medium/short range Division and Brigade communication. Frequency range 1.875-5MHz. MO control. RF output 7W R/T and 10W CW. Range 9 to 30 miles. The receiver was a separate unit. For telegraphy communication to Wireless Set No. 7 I.C.W. was provided.

Key and Plug Assemblies No.1 and No. 2

Summary: Key and Plug Assemblies No. 1 and No. 2 were used with Wireless Set No. 2. Both No. 1 and No. 2 assemblies had two connection cables ending in similar plugs; one connecting to the transmitter and the second to the interruptor which was fitted in the HT convertor unit. It should be noted that both plugs were connected to the spacing (break) contacts of the key so that they were short circuited by the key when the key was up and open when it was down. The only difference between the assemblies was the length of the connection cables.

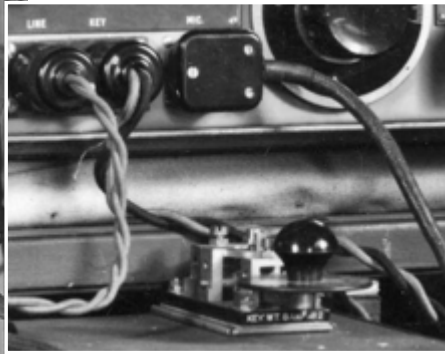
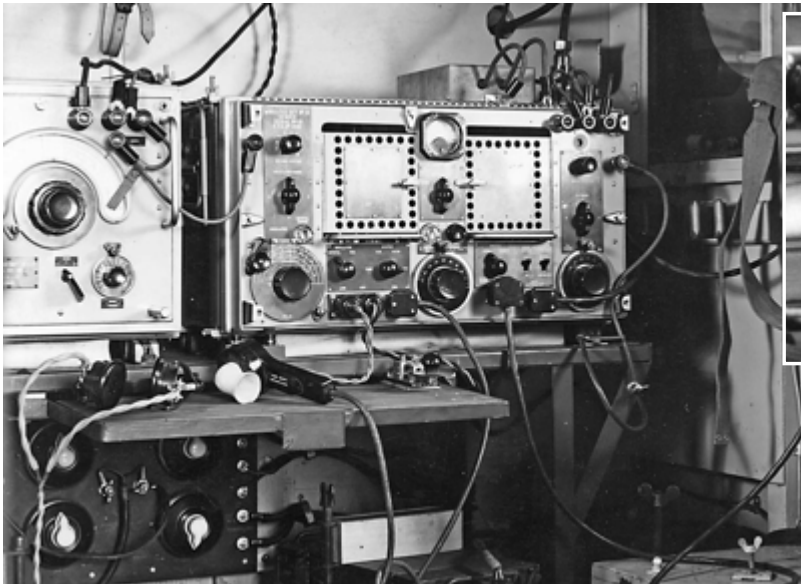

Key and Plug Assembly No. 2B used with No. 12 Set and R107 fitted in Truck 15-cwt, 4-wheeled Wireless. The enlarged section (above) of this photo shows the key and base plate fitted in the slide.

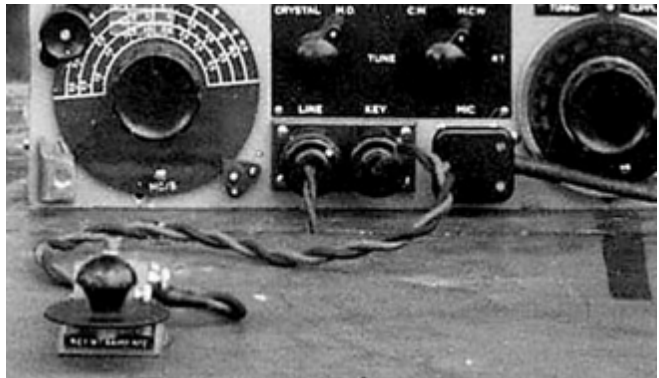
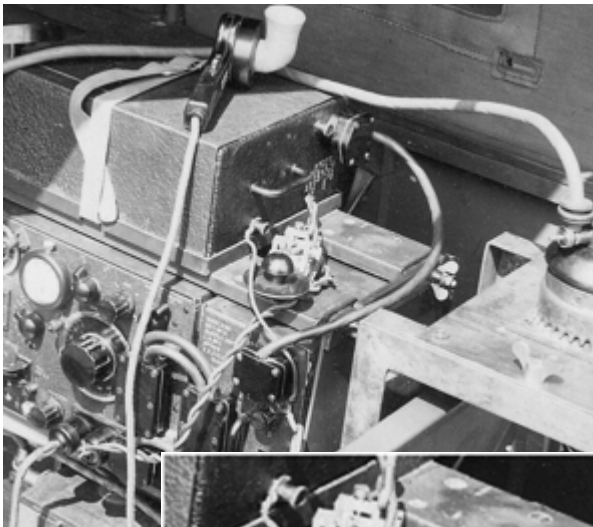

Key and Plug Assembly No. 2B used with Wireless Set No. 33 ground station (above) and Wireless Set No. 11 fitted in an Austin Utility truck (left).



Wireless Remote Control Unit C allowed remote operation of Wireless Set No. 12 or No. 33. A Key and Plug Assembly No. 2B was issued with this unit (above).



Key and Plug Assemblies, Slide No. 1, ZA 4381, was used to secure the base plate of a Key and Plug Assembly No. 2B, C or D on an operator's table. Two different versions are noted.

Key and Plug Assembly No. 2B

Summary: Used with Wireless Sets No. 11, No. 12, No. 12HP, No. 22, No. 33 and No. 53; Remote Control Units C, G No. 2 and H No. 2. This assembly comprised a Key W.T. 8 Amp No. 2 mounted on a metal base plate. Under the key knob was a large round finger rest. A twin connecting cable ended in a Plug No. 10. The length of this cable was about 2ft, which was the only difference between the No. 2 C, D and E assemblies.

Key and Plug Assembly No. 2B (Aust) was almost identical to the British parent model. It was manufactured in Australia (right).

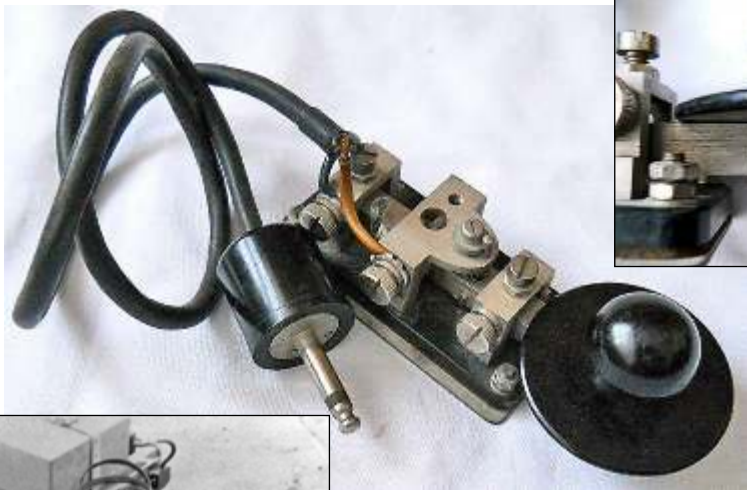

Detail view of key lever showing Australian markings 'D' 'broad arrow' D'.

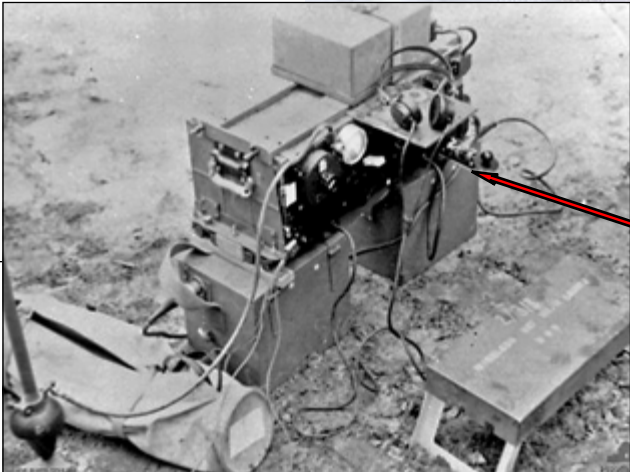

Key and Plug Assembly No. 2B used with a Wireless Set No. 11 (Aust) in a locally manufactured key rest.



Key and Plug Assembly No. 2B (Aust) attached in a slide fitted on the inside of the front panel protection lid of Wireless Set No. 208 (above).



The Plug and Key Assembly No. 2B (Aust) issued with Wireless Set No. 208 Mk.II (above left) and 108 Mk.III (left) was carried in a waterproof cover (ZAA 8882).

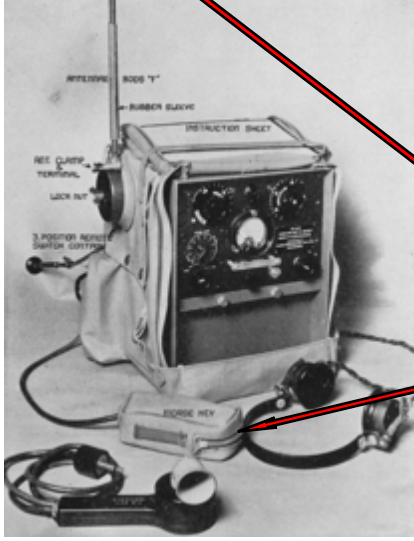

Surviving example of Key and Plug Assembly No. 2B (Aust) with associated waterproof cover.



Key and Plug Assembly No. 2B (Australia)
Summary: Used with Wireless Sets No. 11 (Aust), No. 108 Mk.III, No. 208 and No. 208 Mk.II. Australian manufactured version. Key and Plug Assembly Slides No. 1 (ZA 4381) was used to fix the assembly to a table or the set (where required).

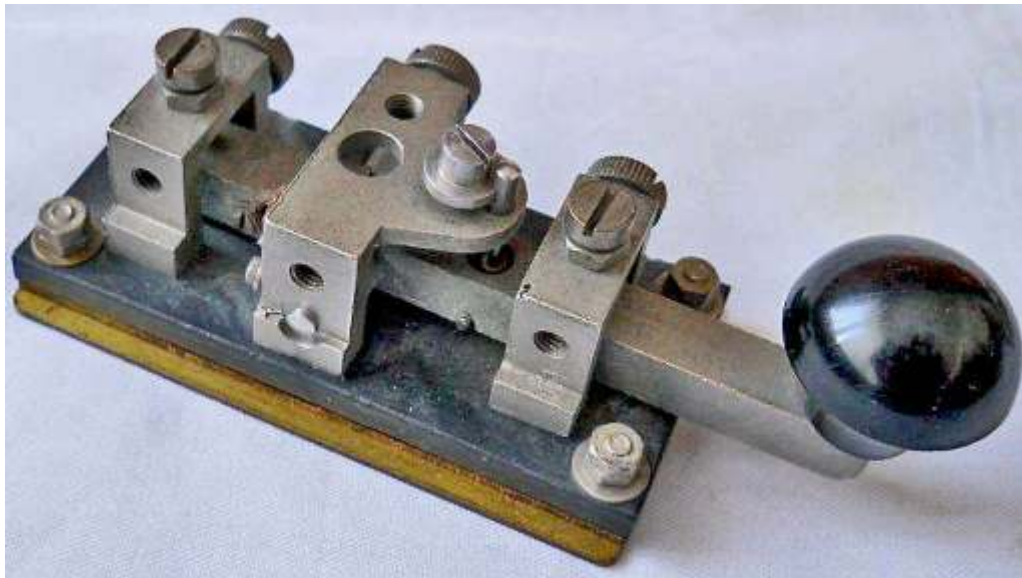

Key and Plug Assembly No. 2B (Can) used a Canadian manufactured Key W.T. 8 Amp No. 2. Unfortunately the lead and plug, and finger rest are missing from this surviving example.

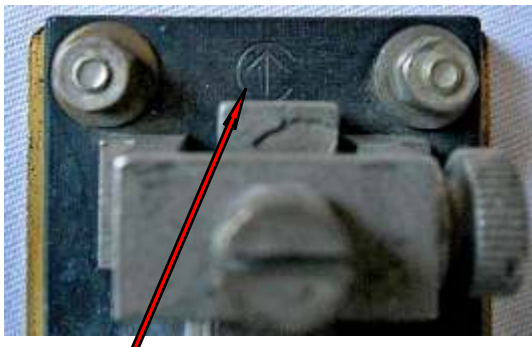

Top view of rear section Canadian No. 2B assembly showing a Canadian 'broad arrow'.



Engraved text on the base plate of Canadian Key and Plug Assembly No. 2B.



Right hand side view of Canadian Key W.T. 8 Amp No. 2 mounted on a base plate. Engraved on the key base side is the maker's name (Northern Electric Co.) and year of production. Note the Paxolin pad between the key base and base plate.

Key and Plug Assembly No. 2B (Can)

Summary: Used with Wireless Set No. 11 (Can). This assembly was similar to the British No. 2B, but produced in Canada. The Morse key was a Key W.T. 8 Amp No. 2 made by Northern Electric Co.



Key and Plug Assembly No. 2B N.Z. fitted on a slide. The key was a copy of the British Key W.T. 8 Amp No. 2, manufactured in New Zealand. The key lever and the three bridges were cast alloy. This assembly required no finger rest as keying was accomplished via a 12V relay. This type of Morse key was also permanently fitted in associated Remote Control Unit A (NZ) and Remote Control Unit WS ZC1 Mk.II RCU (NZ).

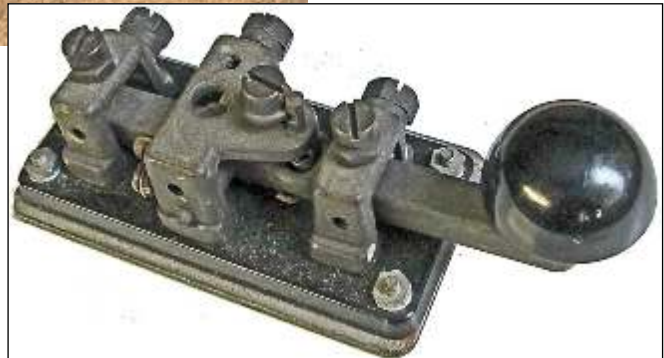

Slide for Key and Plug Assembly No. 2B (NZ) GA201-2.



Base plate with text reading 'Key & Plug Assemblies, No. 2B N.Z.'



Wireless Set ZC1 Mk.I (left) and ZC1 Mk.II were developed and manufactured in New Zealand.

Use: General purpose ground and vehicle station. Frequency coverage 2.2-6.5MHz (Mk.I) and 1.9-8MHz (Mk.II). AM R/T and CW. RF output approximately 2W. MO control. Range 10-15 miles with 8ft rod aerial.

Key and Plug Assembly No. 2B (New Zealand)

Summary: Used with Wireless Set ZC1 Mk.I and ZC1 Mk.II. The assembly was similar to the British parent model, but produced in New Zealand.

Key and Plug Assembly No. 2C used for local keying of Wireless Set No. 33 and Reception Set R107 fitted in a wireless lorry (right).

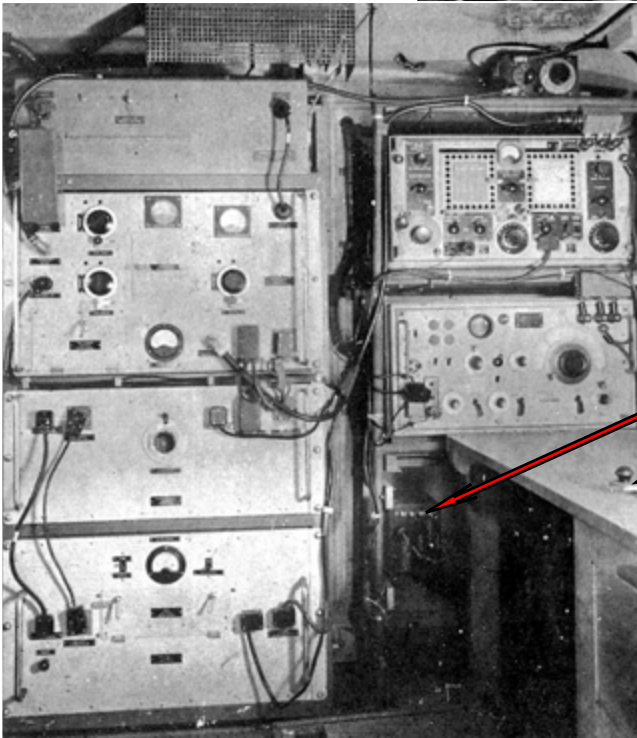
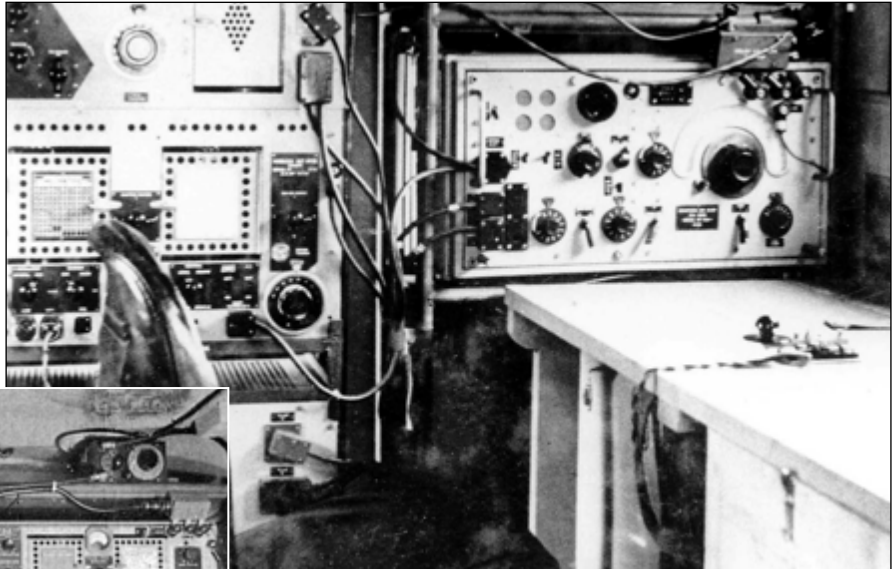

Wireless Set No. 12 HP and Reception Set R107 (left). Local keying was accomplished via Wireless Remote Control Unit G No. 1 (mounted below the R107 and barely visible in this photo) using Key and Plug Assembly No. 2D which was mounted on the operator's table.

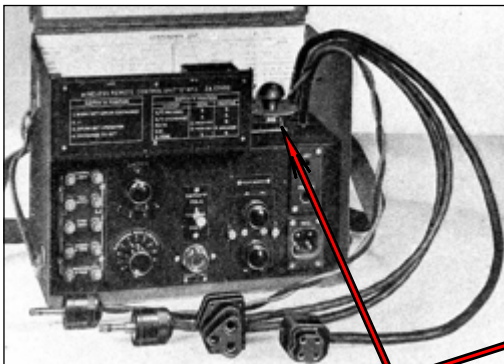

Key and Plug Assembly No. 2E was used with Wireless Remote Control Unit G, No. 2 (above left) and H No. 2 (above right). Note the absence of the finger rest on the key in the H No. 2 unit.

Key and Plug Assemblies Nos. 2C, 2D and 2E

Summary: These assemblies had a metal base plate on which a Key W.T. 8 Amp was mounted. The Morse key had a finger rest and a twin connecting lead ending in a Plug No. 10. The only difference between the C, D and E versions was the cable length.

- The No. 2C assembly was used with Wireless Set No. 11 in an A11 tank and various wireless lorries. It had a long connection cable.

- The No. 2D assembly was widely used with high power stations such as Wireless Sets Nos. 12HP, 33, 53, RCA 4332B etc. in conjunction with Wireless Remote Control Units G No. 1 or H No.1 for local keying.

- Key and Plug Assembly No. 2E was principally used with Wireless Remote Control Units G No. 2 and H No. 2 for remote keying. This assembly had a very short (about 1ft) connection cable.

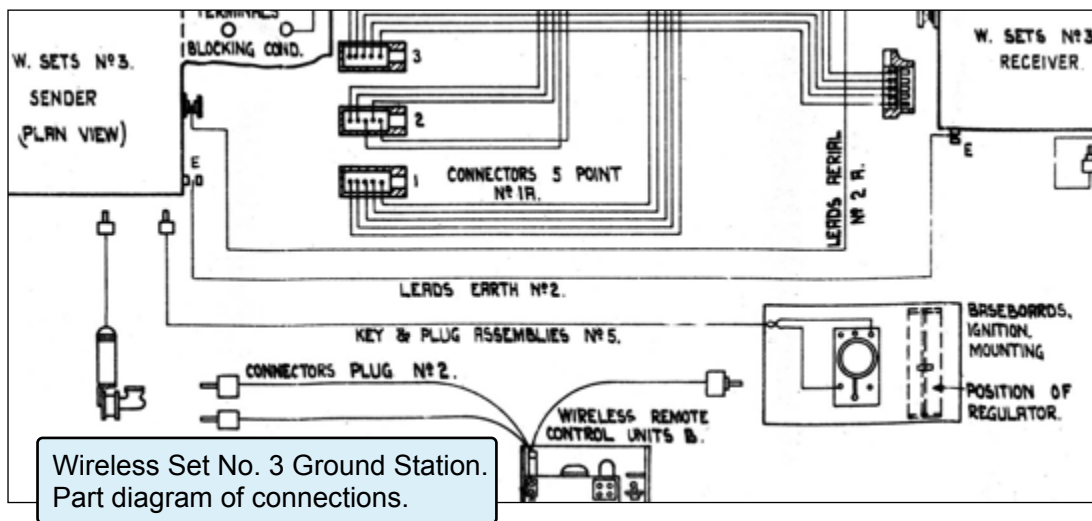
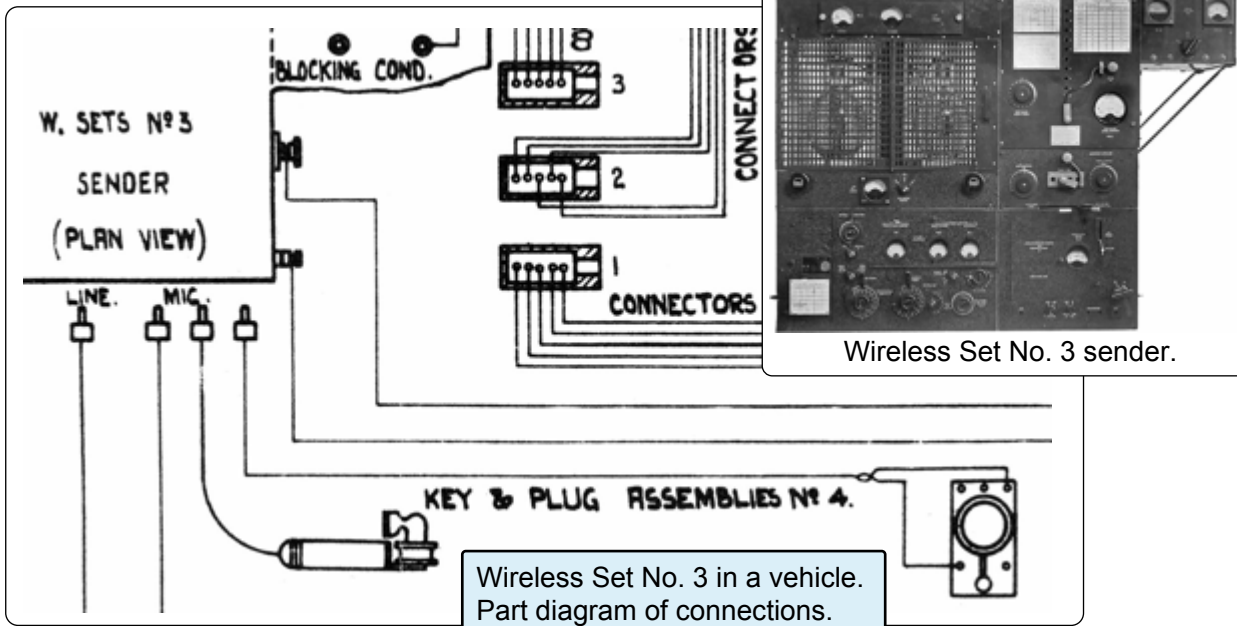

British General Post Office double current Morse key (one of the many versions).

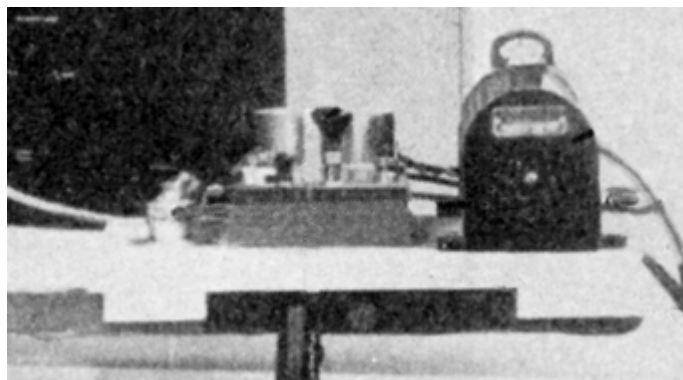

Key and Plug Assembly No. 5 used a GPO double current Morse key and HT regulator mounted on a baseboard. It was used with Wireless Set No. 3 Ground Station.

Key and Plug Assemblies No. 4 and 5

Summary: Used with Wireless Set No. 3 Vehicle Station (No. 4) and Ground Station (No. 5). The Morse key was a British GPO double current telegraph key. The exact model or version which was used with the No. 3 Set is not known.



Enlarged section of the brass base plate showing engraved text 'Key and Plug Assembly No. 6'.

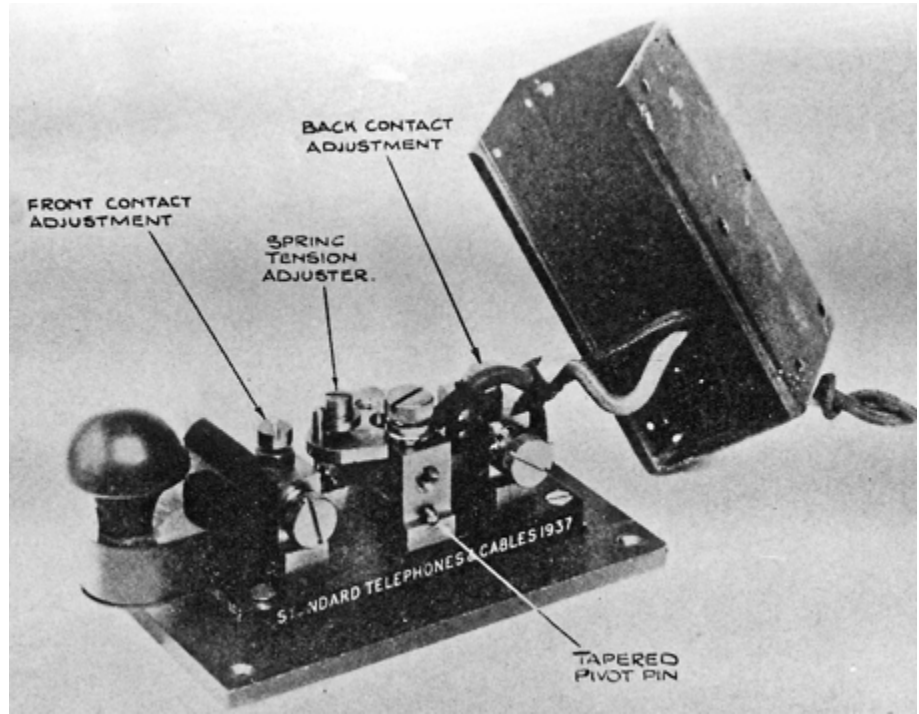

Key and Plug Assembly No. 6 comprised a standard Key W.T. 8 Amp No. 2 or variant. It was mounted on a base plate with a metal protective cover.



Surviving Key and Plug Assembly No. 6 with Key W.T. 8 Amp No. 3 mounted on a brass base plate. Note the insulating sleeve over the key lever.

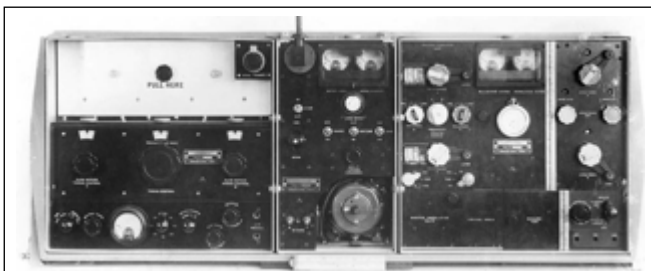

Wireless Set No. 9 (shown above) and No. 9 (Can) were mobile sets developed before World War 2. The sets were used for medium range communication for AFV and Divisional Signals, as a vehicle station in trucks, and as ground station. Frequency range 1.875-5MHz. MO/crystal control. RF output 5W/10W. R/T, MCW, CW. Range up to 35 miles.

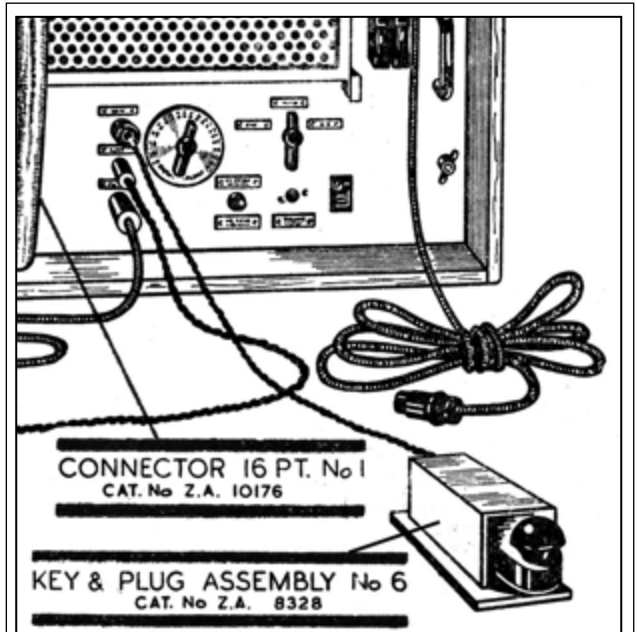

Key and Plug Assembly No. 6 was also issued with Wireless Set No. 36. The frequency range of the set and associated Reception Set R208 was 10-60MHz. It was used by A.A. Command and intended for point to point communication, including gun sites.

Key and Plug Assembly No. 6

Summary: Used with Wireless Sets No. 9, No. 9 (Cdn) and No. 36. The assembly had a base plate on which a Key W.T. 8 Amp No. 2 or variant was attached. The protective cover slid backwards over the Morse key which had a different style of key lever insulation sleeve.

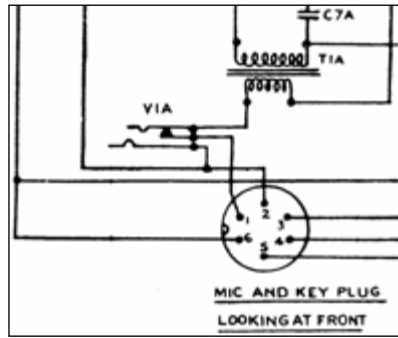
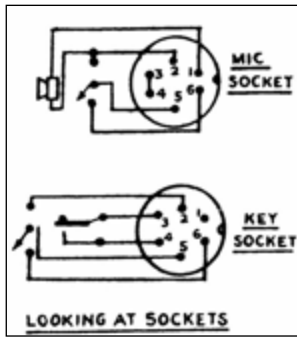

Close-up view of the set plug for connecting the key and plug assembly or the microphone.

Circuit diagram of microphone and Morse key sockets of Wireless Set No. 28 (above left). Part circuit of connections to the microphone and Morse key plug in the set (above right).

Wireless Set No. 28 (right) was a man pack transmitter-receiver developed in early 1940. Use: general purpose Infantry short range communication in forward areas between Company and Battalion HQs. Frequency range 6-9MHz. R/T and CW. MO control. RF output 0.25W. Range 3-5 miles. The set did not come into service as it was decided that the No. 18 Set was more suitable. Only a limited number were produced.



Key and Plug Assembly No. 7

Summary: Believed to be used with Wireless Set No. 28. The Morse key which was issued with Wireless Set No. 28 had a 6-point plug and incorporated a transmit/receive switch, functionally similar to Key and Plug Assembly No. 8 as used with the No. 18 Set. To date no surviving keys have been found and it is assumed that Key and Plug Assembly No. 7 was its designation.

Further details of the shape and size of this assembly had not been found at the time of compiling this overview.



General view of Key and Plug Assembly No. 8 ver. 1 (above).

The same assembly with protective cover removed, showing a Key W.T. 8 Amp No. 2 and 3-tag toggle switch (below).

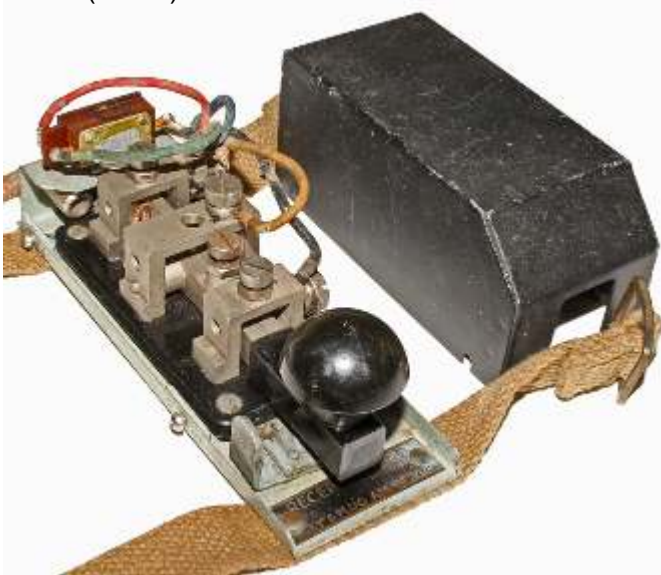

Detail view of send-receive switch lever under the key lever showing a slightly different designation plate reading ASS^{BLY} (above).



Wireless Set No. 18 Mk.III was a manpack set developed in 1940. It was intended for short range communication in forward areas between Battalion HQ and Company HQ. Frequency range 6-9MHz. MO control. RF output 0.25W. R/T, CW. Range up to 10 miles. Wireless Set No. 68 was similar but with a different frequency range.



Key and Plug Assembly No. 8 (Ver. 1)

Summary: Used with Wireless Set No. 18 Mk.II, No. 18 Mk.III, No. 68 P and No. 68 R. Key and Plug Assembly No. 8 had a built-in send-receive switch. The Morse key fitted in the assembly could be any of the many variations of the Key W.T. 8 Amp No. 2, although in the later produced assemblies a Bakelite key lever may be encountered.



Key and Plug Assembly No. 8 had two plugs on a 'Y' lead, one of which connects into the key jack, and the other into the microphone socket, extending the filament switching circuit to the send-receive switch on the key (above).



Internal view of Key and Plug Assembly No. 8 ver. 2 showing Key W.T. 8 Amp No. 2 Mk.III and a send-receive toggle switch with four tags (left).



Detail view of send-receive switch lever directly under the key knob.



The send-receive toggle switch (marked S265) fitted in Key and Plug Assemblies No. 8 (both versions) had four external tags which required a wire bridge (above). Alternatively fitted was a 3-tag toggle switch (an Arrow commercial model, but other models including stores ref No. ZA3812 are noted) with an internal bridge (left).

Key and Plug Assembly No. 8 (Ver. 2)

Summary: Used with Wireless Sets No. 18 Mk.II, No. 18 Mk.III, No. 68 P and No. 68R. This assembly was similar to ver. 1 but had a different designation plate (reading ASSEMBLY).



The opening in the rear of the Key and Plug Assembly No. 8 was intended as stowage for an aerial adapter plug (left). This aerial adapter plug was originally part of Aerial Leads 2ft No. 4 but appeared to be issued separately for connecting a wire aerial. Three different versions of this plug have been identified (right).

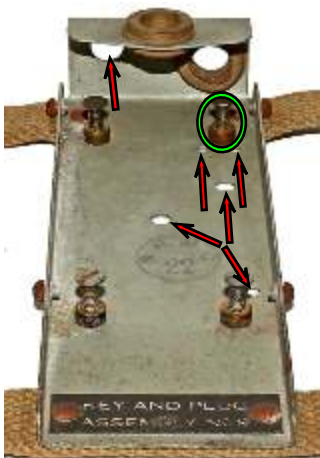

The assembly base plate of Key and Plug Assembly No. 8 (right) was identical to that of the Key and Plug Assembly No. 9 (left). It had similar punching, but some were left unused in the No. 9 key assembly base plate. Note that the position of the top right key base stud differs (green circle), and the reason for a 5th fixing hole on the key base which can be found in many keys.

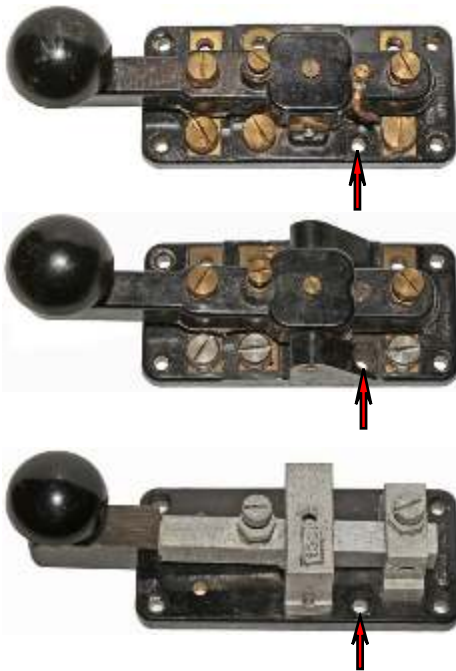

Many of the produced Key W.T. 8 Amp No. 2 Mk.II (top left) and Mk.III (centre left) were produced with a 5th fixing hole in the key base.

In several Morse keys produced in Canada (Key W.T. 8 Amp No. C4, bottom left), and the USA produced Bunnell models an extra fixing hole in the key base can be found. It is neither believed, nor confirmed that these Morse keys ever were used in the British Key and Plug Assembly No. 8.



Not every Morse key fitted in the No. 8 assembly had an extra fixing hole. It was consequently attached with only three screws (here shown a Key W.T. 8 Amp No. 2 Mk.III).

Key and Plug Assembly No. 8

Summary: Used with Wireless Sets No. 18 Mk.II, No. 18 Mk.III, No. 68 P and No. 68 R. Details of production differences/similarities and an aerial adapter plug are covered on this page.



Key and Plug Assembly No. 8A was used with Wireless Set No. 48. It comprised a modified US Army type J-5A flameproof Morse key with a send-receive switch fitted on the top cover plate. The key was mounted on a Paxolin base plate with two canvas leg straps attached to the underside.



U.S. Army flameproof key J-5A (above).



Wireless Set No. 48 was a man pack transmitter-receiver developed about 1942. It was primarily used for short range communication in forward areas within Infantry battalions and RA regiments. Frequency Range 6-9MHz. RF output 0.25W. R/T and CW. MO control. Range up to 10 miles. The set was developed and produced in the USA as an alternative to Wireless Set No.18.

Key and Plug Assembly No. 8A

Summary: Used with Wireless Set No. 48. This assembly was also known as 'Key and Plug Assembly for No. 48 Set' and 'Key for No. 48 Set'. It was principally a modified type J-5A flameproof key fitted on a base plate.



Key and Plug Assembly No. 8B was a tropicalised version of assembly No. 8 ver. 2 (see page 15). It had an olive drab finish, a flexible rubber lead and both plugs were filled with moisture resisting compound. The No. 8B assembly was principally used with Wireless Sets No. 18T and No. 68T.



Internal view of Key and Plug Assembly No. 8B showing a Key W.T. 8 Amp No. 2 Mk.III, and a 3-tag send-receive toggle switch (above and above right).



Front view of Key and Plug Assembly No. 8B (right).

Key and Plug Assembly No. 8B

Summary: Used with Wireless Sets No. 18T and No. 68T. A tropicalised version of the No. 8 ver. 2 assembly.



Key and Plug Assembly No. 9 ver. 1 (top of page), and without protective cover (above). The Morse key fitted in the assembly on the picture was a Key W.T. 8 Amp No. 2 Mk.II with a brass key lever.



Front view of the assembly showing key knob and identification plate.



Wireless Set No. 19 (here shown the British Mk.II model, set without power supply unit). Use: primarily developed for AFVs but later used as a general purpose set. Frequency range 'A' set 2-8MHz; 'B' set 229-241MHz. MO control. R/T, MCW, CW. RF output 'A' set 1.2-2.5W (R/T). Range 'A' set up to 15 miles; 'B' set ¾ mile.

Key and Plug Assembly No. 9 (Ver. 1)

Summary: Used with British Wireless Set No. 19 Mk. I, II and III. Probably an early production version (not confirmed yet) having a Key W.T. 8 Amp No. 2 Mk.II with brass key lever. The protective cover had a black wrinkle paint finish.



General View of Key and Plug Assembly No. 9 ver. 2.



Key and Plug Assembly No. 9 ver. 2 with protective cover opened . The Morse key was a Key W.T. 8 Amp No. 2 Mk.II.



A black fibre disk protected the operator from coming into contact with high tension when inserting the key into the set key socket (above). This was an addition which was occasionally found fitted on other versions.



Wireless Set No. 19 (here shown the British Mk.III model, set without power supply unit). Use: primarily developed for AFVs but later used as a general purpose set. Frequency range 'A' set 2-8MHz; 'B' set 229-241MHz. MO control. R/T, MCW, CW. RF output 'A' set 1.2-2.5W (R/T). Range 'A' set up to 15 miles; 'B' set ¾ mile.

Key and Plug Assembly No. 9 (Ver. 2)

Summary: Used with British Wireless Set No. 19, all versions. Similar to ver. 1 but with a matt black finish on the protective cover.



General view of Key and Plug Assembly No. 9 ver. 3.1.

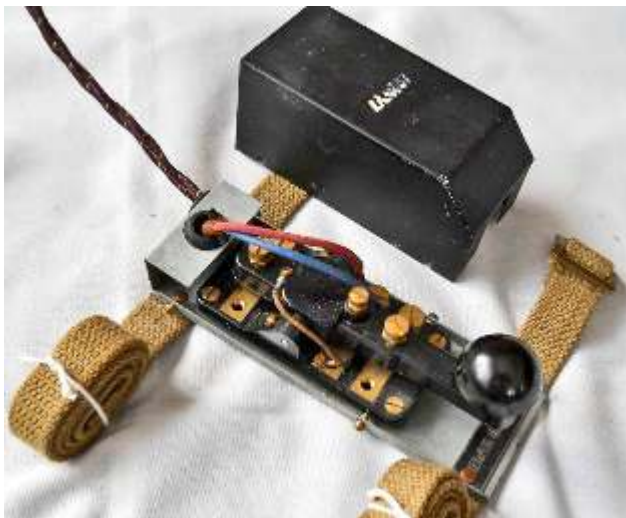

Internal view of Key and Plug Assembly No. 9 ver. 3.1 showing a Key W.T. 8 Amp No. 2 Mk.III. The difference between Key and Plug Assembly No. 9 ver. 3.1 and ver. 3.2 was only a unlacquered identification plate. The differences in the Morse keys were not taken in account.

Key and Plug Assembly No. 9 (Ver. 3.1)

Summary: Used with British Wireless Set No. 19 all versions. Unlacquered identification plate, rectangular protective cover.



General view of Key and Plug Assembly No. 9 ver. 3.2.



Key and Plug Assembly No. 9 ver. 3.2 with protective cover removed showing a Key W.T. 8 Amp No. 2 Mk.III (left). Detail view of the front with key knob and identification plate (right).

Key and Plug Assembly No. 9 (Ver. 3.2)

Summary: Used with British Wireless Set No. 19 all versions. Identification plate lacquered, rectangular protective cover.



Key and Plug Assembly No. 9 ver. 3.3 was principally similar to ver. 3.2, but having a rounded protective cover.



Internal view of Key and Plug Assembly No. 9 ver. 3.3 with Key W.T. 8 Amp No. 2 Mk.III (left) and front view showing the lacquered identification plate (right).

Key and Plug Assembly No. 9 (Ver. 3.3)

Summary: Used with British Wireless Set No. 19 all versions. Lacquered identification plate, rounded protective cover.

Key and Plug Assembly No. 9A ver. 4.1 was principally similar to ver. 3.2 and differed only in having a different type of plug.

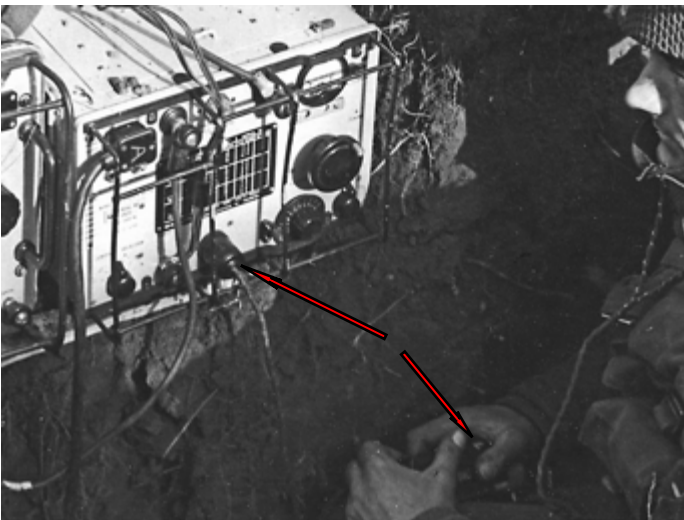

Wireless Sender No. 76 and Reception Set R109A in operational use (left). Note the large No. 10 plug, connecting Key and Plug Assembly No. 9A (strapped to the operator's upper leg) to the transmitter.



Wireless Set (or Sender) No. 76 was a portable transmitter developed in 1943. Use: light-weight self-contained transmitter for rear link communication. Frequency range 2-12MHz. RF output 9W. Crystal control. CW only. Range over 300 miles. It was normally used in conjunction with Reception Set R109A.

Key and Plug Assembly No. 9A (Ver. 4.1)

Summary: Primarily intended and used with Wireless Sender No. 76. Similar to ver. 3.2 but with a different type of plug.



Key and Plug Assembly No. 9AT ver. 4.2.



Key and Plug Assembly No. 9AT was a tropicalised version of ver. 4.1 and almost identical to ver. 4.3.



Key and Plug Assembly No. 9AT (Ver. 4.2)

Summary: Primarily intended and used with Wireless Sender No. 76T. Tropicalised version of ver 4.1 (rubber lead and plated brass hardware items on the Morse key and plug).



Key and Plug Assembly No. 9 Mk.1/1 ver. 4.3 was the tropicalised version of the No. 9 assembly. It was similar to ver. 4.2 except for having a different type of plug.



Front view of Key and Plug Assembly No. 9 Mk.1/1 (above) and with protective cover removed (right). Note that all the brass parts of the Key W.T. 8 Amp No. 2 Mk.III and the plug were plated.



Key and Plug Assembly No. 9 Mk.1/1 (Ver. 4.3)

Summary: Used with British Wireless Set No. 19, probably with later Mk.III T tropicalised versions. Tropicalised and similar to ver. 4.2 but with a different type of plug.



Key and Plug Assembly No. 9 ver. 4.4 with modified connection lead and four point plug (left).

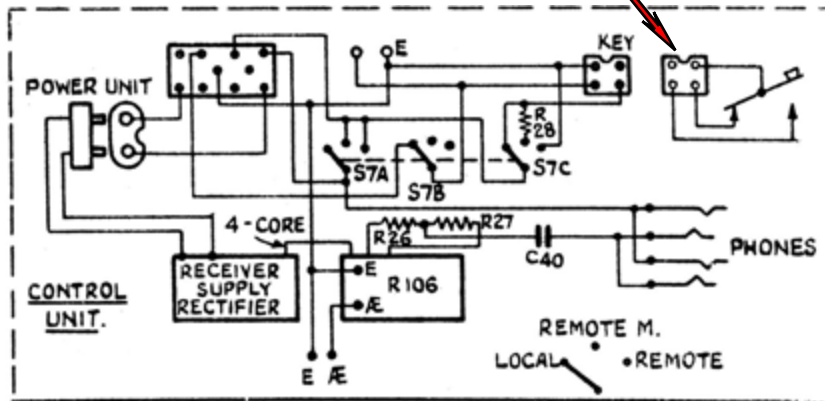

Part circuit diagram of Wireless Set Special type 6X1 showing connections to Morse key. Note that the break (space) contact was used, hence the use of a 4-point plug and socket.

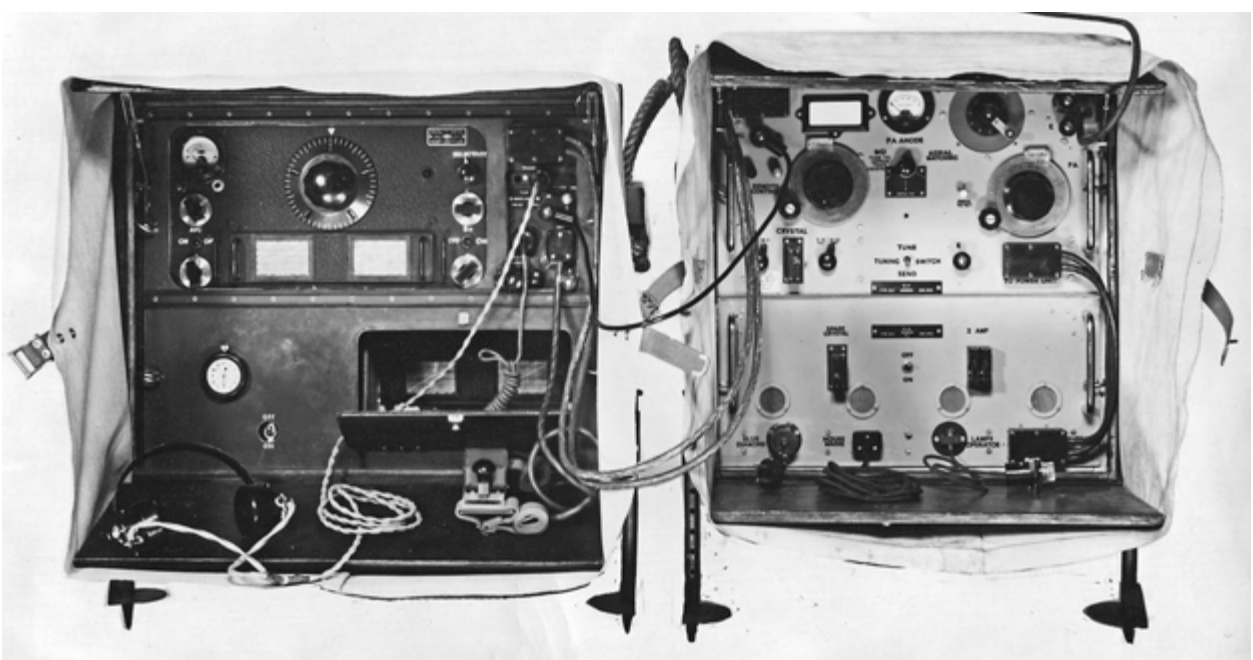

Special Set type 6X1 was a general purpose long range transportable ground station for combined operations. The set was designed for use in the open by forward troops, under tropical conditions if necessary. The transmitter covered 2-12 MHz, and the accompanying R106 receiver 1.7-14MHz.

Key and Plug Assembly No. 9 (Ver. 4.4)

Summary: Used with Wireless Set Special type 6X1. This assembly was essentially a standard No. 9 ver. 2 fitted with a different lead and a four point plug.



Key and Plug Assembly No. 9 ver. 5 was similar to ver. 2 but manufactured in Canada. There are, however, indications that batches of British made keys may also have been issued, marked with a Canadian broad arrow.



Wireless Set No. 9 Mk.I (Can) was a much improved Canadian produced version of Wireless Set No. 9. Frequency range 1.875-5MHz. MO/crystal control. RF output 50W/30W. R/T, MCW, CW. Range up to 50 miles. Wireless Set No. 52 (Can) was a further development of this set.

Key and Plug Assembly No. 9 (Ver. 5)

Summary: Used with Wireless Sets Cdn No. 9 Mk.I, No. 19 Mk.II and Mk.III. Known as Key and Plug Assemblies No. 9, ZA/CAN/BR 0937. Manufacturers number PC 90691C-1. This assembly employed Key, W.T., 8-Amp, No. C2 (ZA/CAN 0982) which had three bridges (although similarly marked assemblies were produced in England). It was later superseded by Key and Plug Assembly Cdn No. 9 Type 1 (ZA/CAN 1643) (ver. 6).



Key and Plug Assembly Cdn No. 9 Type 1.



Internal view of Key and Plug Assembly Cdn No. 9 Type 1. Note Key W.T. 8 Amp No. C4 with only two bridges.



Front view of assembly showing the stamped-in designation (right).

Key and Plug Assembly Cdn No. 9 Type 1 (Ver. 6)

Summary: Used with Wireless Set Cdn No. 19 Mk.II. Known as Key and Plug Assemblies Cdn No. 9, Type 1, ZA/CAN 1643. Manufacturers Number R11950. The Morse key was a Key, W.T., 8-Amp, No. C4 (ZA/CAN 1522) with only two bridges made by Northern Electric Co. The designation 'Key and Plug Assembly R11950' was stamped into the assembly base plate from underneath creating raised lettering under the key lever. This assembly replaced the Key and Plug Assembly No. 9 (PC90691C-1) (ver. 5), issued after the stocks of this version were exhausted.



Key and Plug Assembly Cdn No. 9 Type 2 had a matt black rounded protective cover of pressed steel and a type PL-55 plug (left).

Front view of the No. 9 Type 2 assembly showing a slightly different key lever insulation sleeve (below).



Key and Plug Assembly Cdn No. 9 Type 2 with its protective cover opened showing a Key W.T. 8 Amp No. C3 with two bridges of pressed steel construction (left).



The rear of the assembly base plate had only one opening in the centre and a simplified lead tension restraint.

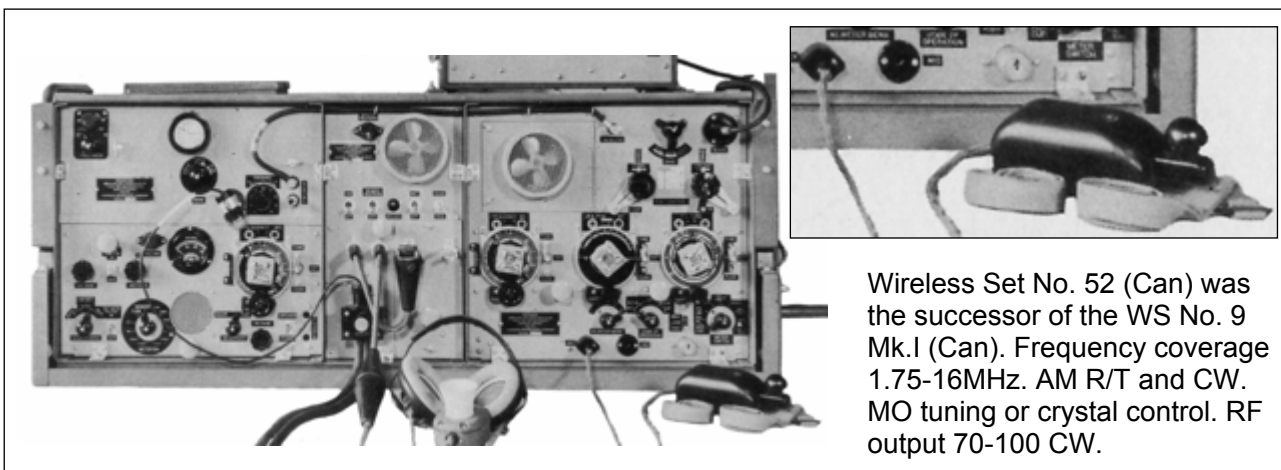

Wireless Set No. 52 (Can) was the successor of the WS No. 9 Mk.I (Can). Frequency coverage 1.75-16MHz. AM R/T and CW. MO tuning or crystal control. RF output 70-100 CW.

Key and Plug Assembly Cdn No. 9 Type 2 (Ver. 7)

Summary: Used with Wireless Sets No. 19 Mk.III (Can) and No. 52 (Can). Known as Key and Plug Assemblies, Cdn, No. 9, Type 2 ZA/CAN 0715 (Manufacturers Number RCA 110072-1) made by Westclox. The Morse key was a Key W.T. 8-Amp No. C3 (ZA/CAN 0926). It had a U shaped key lever and two bridges of pressed steel construction.



Key and Plug Assembly Cdn No. 9 Type 2/T was exclusively produced for Wireless Set No 29 (Can). The assembly was principally similar to No. 9 Type 2 (ver. 7), with an element of tropicalisation such as a rubber lead and covered plug.



Front view showing the stamped-in designation and stores reference numbers.

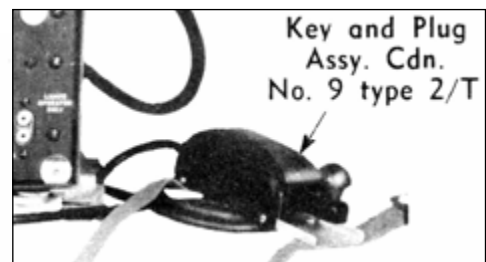
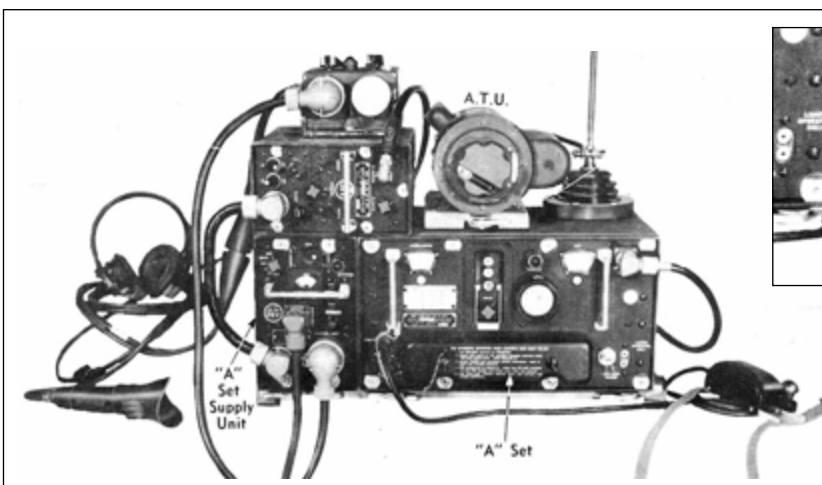

Wireless Set No. 29 (Can) was intended as a replacement for the No. 19 Set. When production started the war was over and only a very limited number were eventually produced.

Key and Plug Assembly Cdn No. 9 Type 2/T (Ver. 8)

Summary: Used with Wireless Set No. 29 (Can). Known as Key and Plug Assembly Cdn No. 9 Type 2/T (ZA/CAN 2320) made by Westclox. The Morse key was a Key W.T. 8-Amp No. C3 (ZA/CAN 0926) having two bridges of pressed steel construction.



Key and Plug Assembly No. 9 ver. 9.1 was produced in the U.S.A. by J.H. Bunnell. Most significant differences to the British parent assembly were a type PL-55 plug and a smaller key knob.

Key and Plug Assembly No. 9 ver. 9.1 with its protective cover removed (right). The Key W.T. 8 Amp No. 2 had three bridges and was fitted on a black wrinkle finish assembly base plate with a similarly finished protective cover.

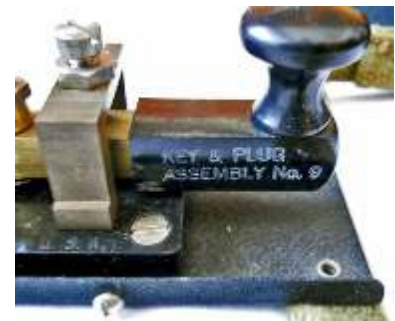

The assembly designation was ink stamped on the Morse key lever insulation sleeve (above). Note the smaller and differently shaped key knob.



Wireless Set No. 19 Mk.II produced by RCA in the USA. Use: primarily developed for AFVs but later used as a general purpose set. Frequency range 'A' set 2-8MHz; 'B' set 229-241MHz. MO control. R/T, MCW, CW. RF output 'A' set 1.2-2.5W (R/T). Range 'A' set up to 15 miles; 'B' set ¾ mile.

Key and Plug Assembly No. 9 (Ver. 9.1)

Summary: Used with Wireless Set No. 19 Mk.II produced in USA. Based on the British No. 9 ver. 2; produced by J.H. Bunnell having a different key knob and type PL-55 plug.



Key and Plug Assembly No. 9 ver. 9.2 was produced in the U.S.A. by J.H. Bunnell. It was a variant of ver. 9.1 with a plated assembly base plate and its designation stamped into this plate.



Key and Plug Assembly No. 9 ver. 9.2 had a plated assembly base plate and a black wrinkle finished protective cover. The Key W.T. 8 Amp No. 2 had three bridges.



Front view of the No. 9 ver. 9.2 assembly. Note a differently shaped key knob and the designation stamped in the assembly base plate.

Key and Plug Assembly No. 9 (Ver. 9.2)

Summary: Used with Wireless Set No. 19 Mk.II produced in USA. A variant of ver. 9.1 with only minor differences.



Key and Plug Assembly No. 9 ver. 9.3 had a black wrinkle finish assembly base plate and protective cover. The key bridges were pressed metal, permanently riveted to the Bakelite key base (left). The designation was ink stamped on the assembly base plate, just below the key knob (below).



Wireless Set No. 19 Mk.II. Here shown a later USA lend-lease production (Zenith) with Cyrillic lettering. Use: primarily developed for AFVs but later used as a general purpose set. Frequency range 'A' set 2-8MHz; 'B' set 229-241MHz. MO control. R/T, MCW, CW. RF output 'A' set 1.2-2.5W (R/T). Range 'A' set up to 15 miles; 'B' set 3/4 mile.

Key and Plug Assembly No. 9 (Ver. 9.3)

Summary: Used with Wireless Set No. 19 Mk.II produced in USA. This assembly appears to be a simplified production of ver. 9.1 embodying an easier and more cheaply produced key.



Key and Plug Assembly No. 9 ver. 10.1 was issued with Wireless Set No. 19 Mk.II produced in the USA. This assembly was similar to ver. 10.2. Note the type PL-55 jack plug and low profile protective cover.



Late post-war production American type J-37 key (above). Compare this Morse key with the modified version used in Key and Plug Assembly No. 9 ver. 10.1 (right).

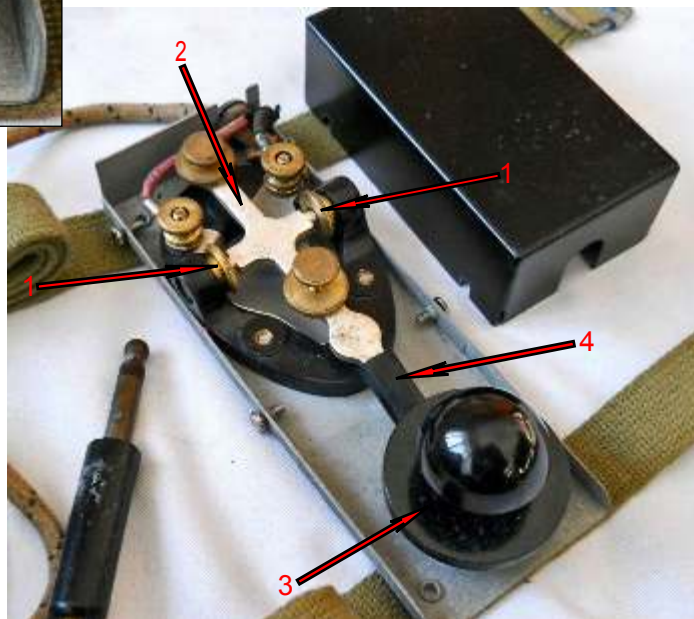

Internal view of Key and plug Assembly No. 9 ver. 10.1 showing a modified type J-37 key with arrows showing the most significant differences to the standard type J-37 key (above).

The knurled key lever set nuts were moved to meet the overall width requirements of the assembly.

Apart from the modified key lever suspension (1) and a narrower lever (2), the key had a mushroom shaped knob and finger rest (3), and a rubber insulation sleeve over the key lever (4).

Key and Plug Assembly No. 9 (Ver. 10.1)

Summary: Used with Wireless Set No. 19 Mk.II produced in USA. Similar to ver. 10.2 but having a slightly different variation of modified type J-37 key with a brass lever and other hardware. It was manufactured by Alden Products Company, Mass.



Key and Plug Assembly No. 9 ver. 10.2 was issued with Wireless Set No. 19 Mk.II produced in the U.S.A. It was nearly identical to ver. 10.1. Note the use of an American type PL-55 jack plug.



Front view of Key and plug Assembly No. 9 ver. 10.2 (above).



One of the many variations of the American type J-37 key (above).



Internal view of Key and plug Assembly No. 9 ver. 10.2 showing a modified type J-37 key with black finish hardware. For more details see page 35.

Key and Plug Assembly No. 9 (Ver. 10.2)

Summary: Used with Wireless Set No. 19 Mk.II produced in USA. Nearly identical to ver. 10.1 but with a slightly different variation of a type J-37 key. It was manufactured by Alden Products Company, Mass.



Key and Plug Assembly No. 9 ver. 11 was produced in Australia. This surviving example was fitted with an Australian produced Key W.T. 8 Amp No. 2 Mk.II with three bridges (see below right).

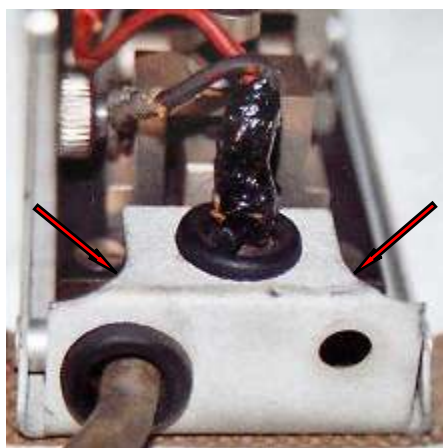

The main difference between Key and Plug Assembly No. 9 ver. 11 and all other versions (except the later Canadian versions 6, 7 and 8) were cut-outs on the back of the assembly base plate (see above).

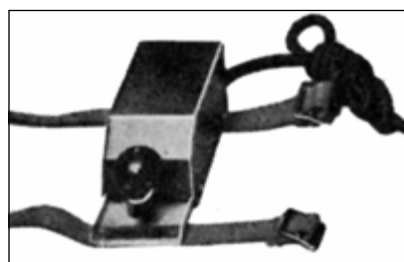
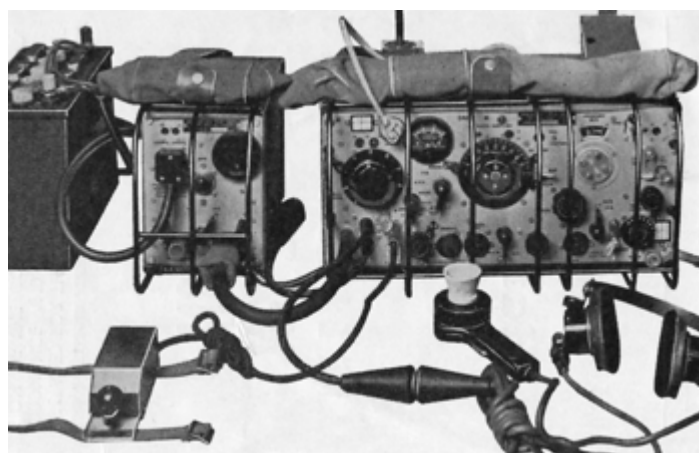

Wireless Set No. 122 was developed and produced in Australia. Use: general purpose vehicle and ground set. Frequency range 2-8MHz. R/T and CW. RF power output 4W R/T. Range up to 30 miles.

Key and Plug Assembly No. 9 (Ver. 11)

Summary: Used with Wireless Sets No. 19 (Aust), No. 22 (Aust) and No. 122 (Aust). Similar to the British Key and Plug Assembly No. 9 ver. 2.

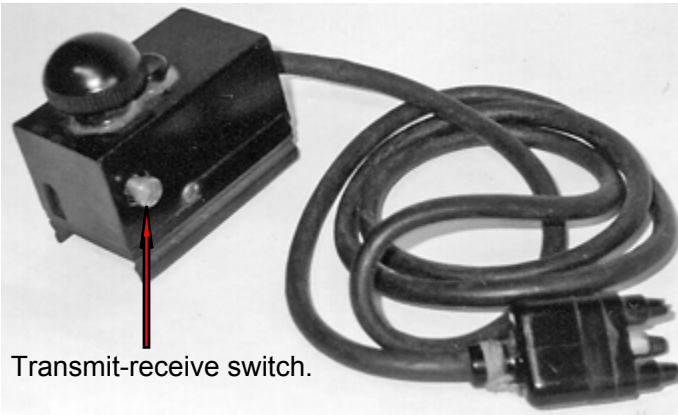

Transmit-receive switch.

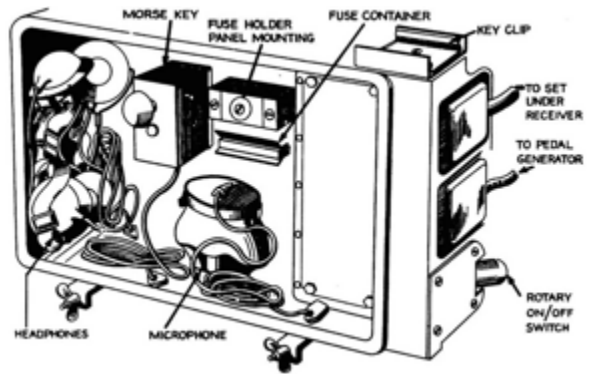

Key and Plug Assembly No. 17 embodied a miniature Morse key with a built-in transmit-receive switch (press buttons, one on each side of the key body). It was normally used fitted on a key clip on top of the Case Accessory No. 3 (above right).

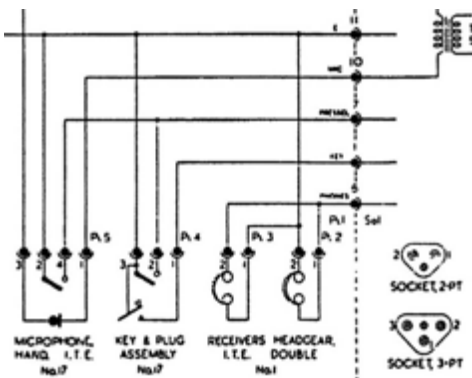

Part of circuit diagram showing connections of Key and Plug Assembly No. 17 to the No. 42 Set.



Wireless Set No. 42 was a portable transceiver developed in 1944/45. Use: general purpose vehicle/animal pack and man pack station. Frequency range 1.6-12.8MHz. MO control. RF output 10W. R/T (AM and FM) and CW. Range up to 25 miles. Limited production, eventually abandoned.

Key and Plug Assembly No. 17

Summary: Key and Plug Assembly No. 17 was exclusively developed for use with Wireless Set No. 42. The key included a transmit-receive switch.

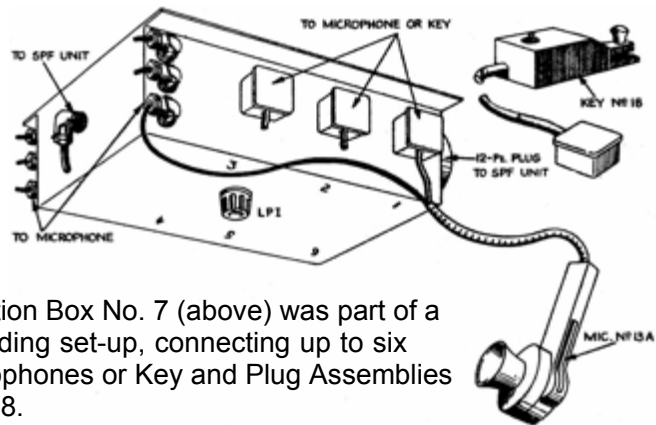
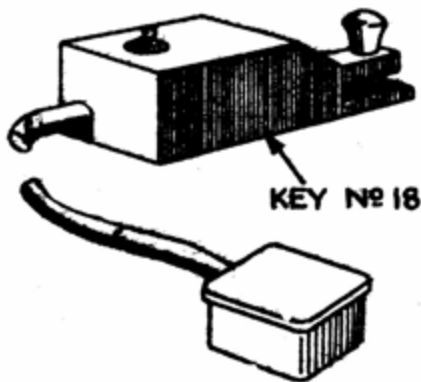

Junction Box No. 7 (above) was part of a recording set-up, connecting up to six microphones or Key and Plug Assemblies No. 18.

Key and Plug Assembly No. 18

Summary: Used with Wireless Set No. 19 SPF. Key and Plug Assembly No. 18 was a modified No. 9 assembly, with a switch fitted on top of the protective cover and a different lead with a four-point plug. It was used for recording CW messages to simulate a net of transmitters.



Key and Plug Assembly No. 19 was developed for Wireless Set No. 62, but later also issued with Wireless Set C12. Although similar to the Key and Plug Assembly No. 9, its internal construction differed, particularly at the rear where a 5-pt socket was fitted, and a cable ending in a 5-pt drop lead plug.

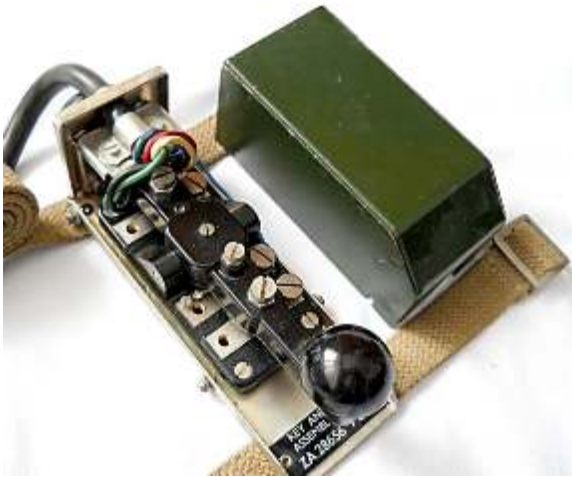

Internal view of Key and Plug Assembly No. 19 showing a Key W.T. 8 Amp No. 2 Mk.III. Note the different construction of the cable tension restraint and position of the cable entry.



Wireless Set No. 62 was developed in 1943/44 as a replacement for the No. 22 Set, but later issued as a substitute for the No. 42 Set which did not materialise before the end of WW 2.



Wireless Set C12 was an interim replacement for the No. 19 Set because of the delays in the development of Station Radio C13. Use: General purpose HF communication. Frequency range 1.6-10MHz. RF output 5W R/T. MO control with two preset channels. Range 15 miles.

Key and Plug Assembly No. 19

Summary: Used with Wireless Set No. 62 and Wireless Set (later Station Radio) C12. It had many similarities to the Key and Plug Assembly No. 9 but fitted with a 5-point snatch socket and drop lead and plug. The snatch plug connected to one of the two snatch sockets on the set drop leads and a second headgear assembly plugged into the snatch socket at the rear of the assembly.



Wireless Set No. 43 (Can) was a transmitter for mobile or fixed operation, developed in 1943. It was primarily intended as general purpose high power transmitter for mobile or static stations. Frequency range 2-12MHz. MO and crystal control. RF output up to 400W. Range up to 75 miles as mobile station. The associated receiver was a Canadian Reception Set VRL.

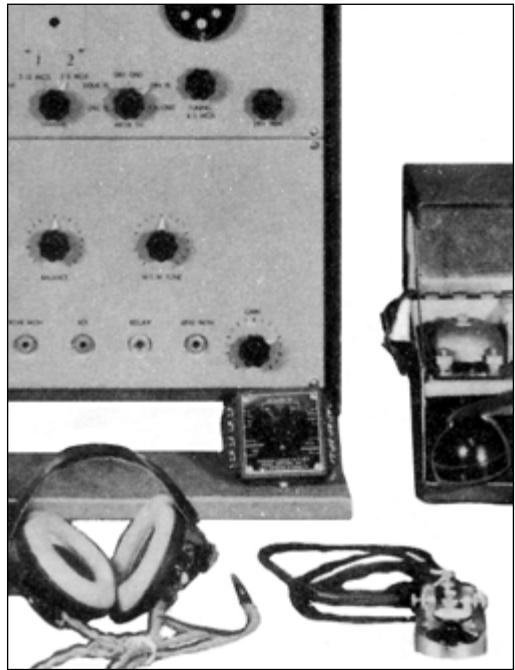

The No. 43 Set key and plug assembly was part of the complete station delivered from the manufacturer and most probably a variant of the American type J-37 key, mounted on a heavy base. The main difference to a standard type J-37 was the addition of a large round finger rest fitted below the original knob.

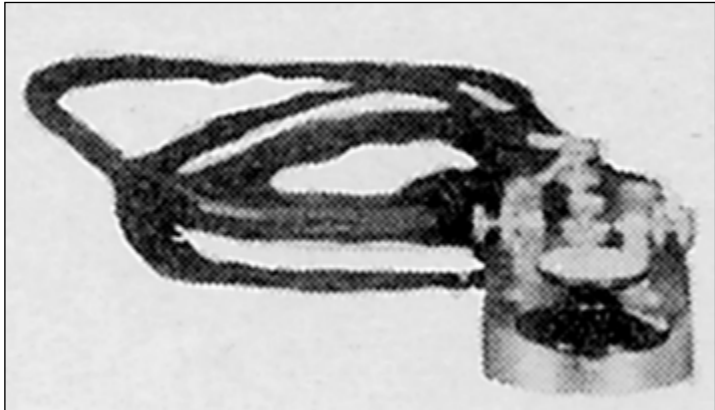

Key WT complete with cord and plug

Summary: Used with Wireless Set No. 43 (Can). This Canadian key and plug assembly was part of a complete Wireless Set No. 43 (Can) installation. It comprised principally a slightly modified type J-37 Morse key. No Army V.A.O.S. number was issued; the assembly was known as 'Key WT complete with cord and plug'. It was manufactured by Signal Electric Co. as type R-62.

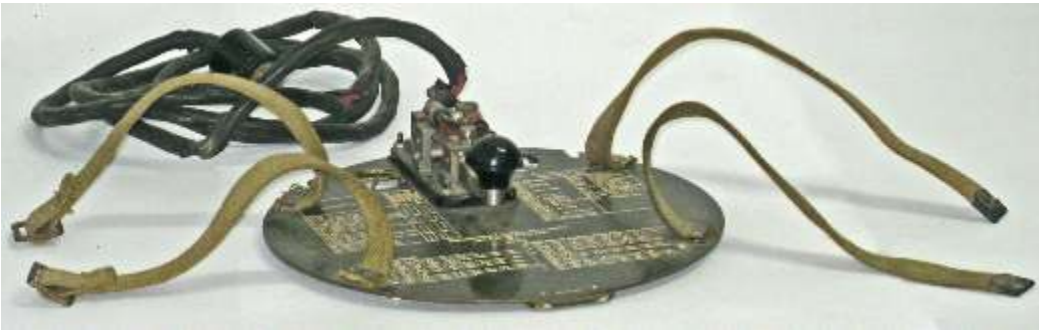

Wireless Remote Control Unit H (Aust.), Key, Plug and Plate Assy. No. 1, ZAA1120 (above).



Wireless Remote Control Unit H (Aust.), Key, Plug and Plate Assy. No. 2, ZAA1121 (right).

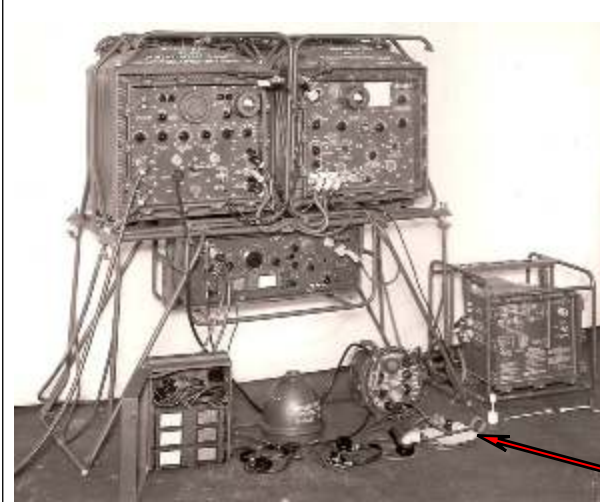

Wireless Set No. 153 was a fully tropicalised hermetically sealed medium power transmitter, usually associated with Reception Set No. 8C. The set was intended as a substitute for Wireless Set No. 133. Frequency range: 2-20MHz. MO or crystal control. RF output 100W R/T, 300W CW.

Local and remote operation was effected by Wireless Remote Control Unit H (Aust) No. 1 (local unit) and No. 2 (remote unit). The covers of these units were made in a most unusual shape providing an effective dust and moisture seal. The Morse key assembly was stored inside the remote control unit when not in use.

Wireless RCU H (Aust) Key, Plug and Plate Assembly

Summary: Used with Australian Wireless Set No. 153. This assembly comprised an Australian Key W.T. 8 Amp No. 2 with cable and plug, fitted on a round wooden plate (Key, Plug and Plate Assembly) which could be stowed on top of the egg-shaped container enclosing the Wireless Remote Control Unit H (Aust) No. 1 or No. 2. The assemblies differed only by the printed text on the plate.

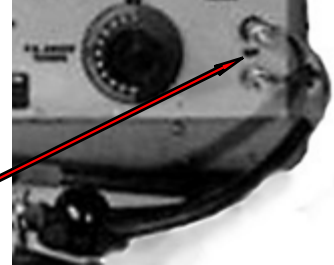

Type 3R2018 Morse Key was used with Teleradio 3BZ and AMC 145. This assembly comprised a Key W.T. 8 Amp No. 2 manufactured by AWA, mounted on a wooden base. The cable terminated in two lugs, probably hooked, to connect to two terminals on the 3BZ/AMC 145. This construction allowed a simple connection to any type Morse key as it required no plug.



Teleradio 3BZ was a general purpose transmitter-receiver manufactured by AWA in Australia. It was used in the SW Pacific campaign and the Coastwatchers Organisation in World War 2. Frequency range 2.5-10MHz. Crystal control. AM R/T and CW. RF output 10-13.5W. The AMC 145 was similar and a Reciprocal Lend Lease version of the 3BZ supplied to the US Forces.

Type 3R2018 Morse Key (AWA)

Summary: Used with Australian Teleradio 3BZ and AMC 145. An Australian manufactured Key W.T. 8 Amp No. 2 mounted on a wooden base.



The Type B50410 Hand Key looks similar to a Key and Plug Assembly No. 9 with the knee straps and protective cover omitted, fitted with a different type of plug.

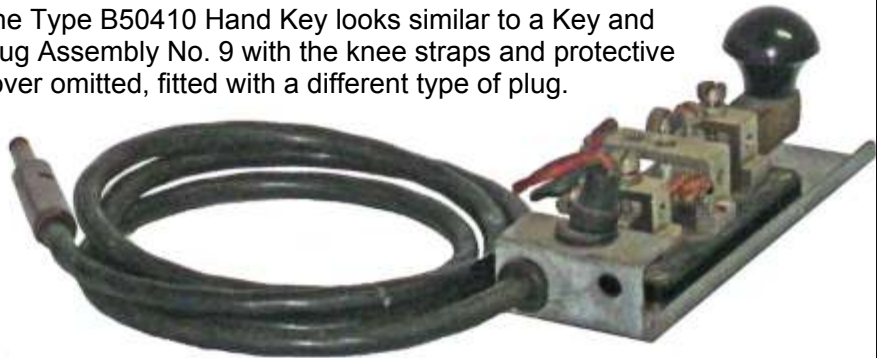

The Australian AMT-150 (previously known as TW-12) Portable Radio Telephone/Telegraph Transmitter was a Lend Lease set produced by AWA for the US Forces. Frequency range 1.5-15 MHz. MO control with 6 spot frequencies. AM R/T, MCW and CW. RF output 15-50W.

Type B50410 Hand Key (AWA)

Summary: Used with Australian AMT-150 Portable Radio Telephone/Telegraph Transmitter. Principally a Key and Plug Assembly No. 9 without protective cover and canvas knee straps.

S.E.E. (Signals Experimental Establishment) Report No. 242, dated March 1924, revealed the first recorded use of the Key W.T. 8 Amp (right).



Front view of Key W.T. 8 Amp (not in right perspective).

S.E.E. REPORT NO.242 - March, 1924.

KEY FOR W/T SETS.

- ...0... -

A key designed with the contacts fixed at the top of the pivoted arm instead of at the bottom is now being embodied in certain sets. The arm of the key being pivoted only a short distance from the base (see sketch below), allows of a considerable reduction in the overall height.

One advantage of the reduced height is, that where the key has been fitted to the lid of an instrument for operating, it has been found unnecessary to remove it when closing the set.

F.U.P.

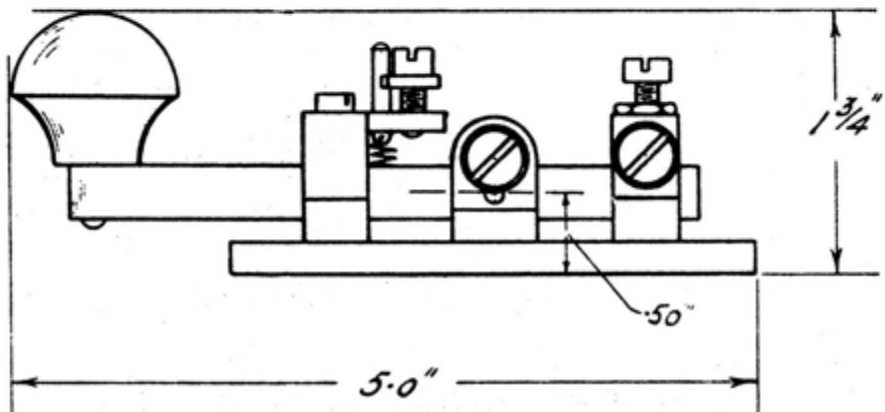

Appendix 1: Key W.T. 8 Amp (No. 1).

Key W.T. 8 Amp (*Design 1 ver. A*), had three bridges with the spring tension adjuster fitted on the front bridge. It had not a space (break=NC) contact and there was no flexible connection between the key lever and middle bridge. The surviving key shown above had probably the centre and rear bridges 180° reversed (compared to the drawing above).

The lack of a space contact was the main reason for the development of the Key W.T. 8 Amp No. 2 in about 1927 (*Design 1 ver. B*) which had a space contact fitted on the front bridge and the spring tension adjuster on the middle bridge. Still later a simpler spring tension adjuster system was fitted on the key lever (*Design 1 ver. C and Design 2 ver. A-C*).

Key W.T. 8 Amp. Basic design No. 1.



Design 1 ver. A had three bridges and the spring tension adjuster on the front bridge. It had neither a space contact nor a flexible connection. (See Appendix 1)

Design 1 ver. B had three bridges and the spring tension adjuster on the middle bridge (left). The contacts were placed on the top of the key lever. The space contact (break=NC) was at the front and the mark (make=NO) contact was the rear stop. (Key W.T. 8 Amp No. 2. left)

Design 1 ver. C had three bridges and was very similar to ver. B. The main difference was a simplified compression spring tension adjuster mounted on the key lever (left). This type of spring tension adjuster was used on any of later Design No. 2 versions. (Key W.T. 8 Amp No. 2. left)

Key W.T. 8 Amp. Basic design No. 2.



Design 2 ver. A had a simplified construction with the fixed contacts embedded in the Bakelite key base. The space contact (break) was at the rear and the mark (make) contact on the front, reversed compared to design No. 1. The contacts were on the bottom of the key lever. (Key W.T. 8 Amp. No. 2 Mk.II. left)

Design 2 ver. B had a Bakelite key base which was identical to ver. A. The key lever was a Bakelite moulding but otherwise having many similarities to the ver. A key lever. (Key W.T. 8 Amp No. 2 Mk.II. left)

Design 2 ver. C had a key lever of moulded Bakelite identical to ver. B. The key base was an all Bakelite moulding with embedded fixed contacts differing in many aspects to the key base of ver. A and ver. B. (Key W.T. 8 Amp Mk.III. left)

Appendix 2: Evolution of Key W.T. 8 Amp.

Two basic designs of this British Morse key can be identified: **Design No. 1** with three bridges (three principal versions), and **Design No. 2** with the fixed contacts embedded in the key base (three principal versions). Each version has many variations which are not described in this publication (unless of interest to a specific key and plug assembly) as these minor differences are not particularly relevant to the main purpose of this publication. Keys manufactured abroad, mainly copies of the British designs have not been included.

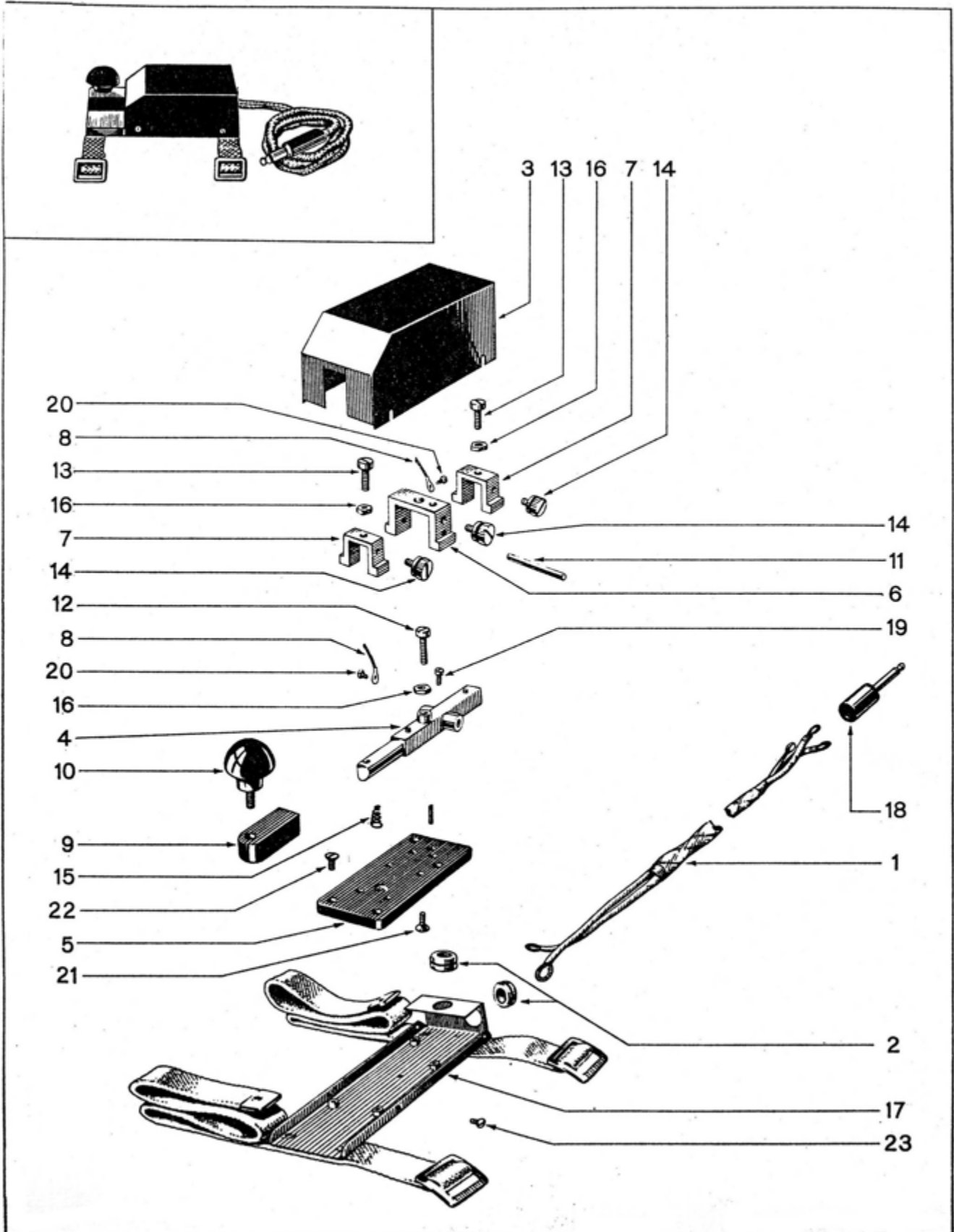

KEY AND PLUG ASSEMBLIES, NO. 9

Appendix 3 - 1.

Exploded view of Canadian Plug and Key Assembly No. 9, showing all components. Scan taken from Canadian EMERs FZ256/3. See next page for designation and V.A.O.S. Numbers.

Det. No.	DESIGNATION	No. per Illus.	V. A. O. S.		Manufacturers Number	Cir. Ref.	Repair Schedule						
			Sect.	Number			Unit	Echelon					
								1st	2nd	4th			
	<p>● KEY AND PLUG ASSEMBLIES NO. 9</p>												
1	● CORDS, 2-Core, 54-in.....	1	Z1	ZA/CAN/BR 0937	PC 90691C-1		R	R	R				
			Z1	ZA/CAN 0979	PCA 110113-1 PC 90691C-11		X	X	R				
2	GROMMETS, Rubber, 5/16-in. ID, 7/16-in. x 1/16-in. panel.....	2	Z1	ZA/CAN 0984	K 4534-7							X	
3	HOUSINGS, Metal, Key & Plug Assemblies, No. Cl	1	Z1	ZA/CAN 0981	PC 90691C-8							R	
	KEYS, W/T, 8-Amp., No. C2.....	1	Z1	ZA/CAN 0982	PC 90691C-12							R	
4	BARS, Keys W/T 8-Amp., No. Cl.....	1	Z1	ZA/CAN 0985	PC 90691C-15							R	
5	BASES, Phenolic, Keys W/T 8-Amp., No. Cl.....	1	Z1	ZA/CAN 0986	PC 90691C-13							R	
6	BRACKETS, Centre, Keys W/T 8-Amp., No. Cl.....	1	Z1	ZA/CAN 0987	PC 90691C-14							R	
7	BRACKETS, End, Keys W/T 8-Amp., No. Cl.....	2	Z1	ZA/CAN 0988	PC 90691C-24							R	
8	CONNECTIONS, Flexible, Keys W/T 8-Amp, No. Cl.....	1	Z1	ZA/CAN 0989	PC 20286							R	
9	GUARDS, Keys W/T 8-Amp., No. Cl.....	1	Z1	ZA/CAN 0991	PC 90691C-20							R	
10	KNOBS, Keys W/T 8-Amp., No. Cl.....	1	Z1	ZA/CAN 0992	R 11950-17							X	
11	PINS, Keys, W/T 8-Amp., No. Cl.....	1	Z1	ZA/CAN 0993	PC 90691C-23							R	
12	SCREWS, Adjusting, Keys W/T 8-Amp., No. Cl....	1	Z1	ZA/CAN 0994	PC 90691C-21							R	
13	SCREWS, Contact, Keys W/T 8-Amp., No. Cl.....	2	Z1	ZA/CAN 0995	R 11950							R	
14	SCREWS, Terminal, Keys W/T 8-Amp., No. Cl....	3	Z1	ZA/CAN 0996	PC 9852A							R	
15	SPRINGS, Helical, Keys W/T 8-Amp., No. Cl....	1	Z1	ZA/CAN 0997	PC 90691C-22							R	
16	NUTS, BA, Brass, Hex, No. 2.....	3	Z2	ZB/CAN 3203	R 11753-2							R	
17	PLATES, Metal, Adaptor, Key & Plug Assemblies No. Cl.....	1	Z1	ZA/CAN 0983	PC 90691C-3							R	
18	PLUGS, Single, No. Cl.....	1	Z1	ZA/CAN 0980	PC 90691C-25							R	
	MOUNTING HARDWARE												
19	SCREWS, BA, Brass, Ch H, No. 6 x 1/4-in.....		Z2	ZB/CAN 2827	PC 30108							R	
20	SCREWS, BA, Brass, Ch H, No. 8 x 1/8-in.....		Z2	ZB/CAN 0990								R	
21	SCREWS, BA, Brass, Csk H, No. 4 x 5/16-in....		Z2	ZB/CAN 2613	R 11713-5							R	
22	SCREWS, BA, Steel, Csk H, No. 4 x 5/16-in....		Z2	ZB/CAN 3163	R 11709-5							R	
23	SCREWS, BA, Steel, RH, No. 6 x 1/8-in.....		Z2	ZB/CAN 0797	R 11702-2							R	

● These items only are carried in Ordnance as Spares. Full designation and V.A.O.S. number MUST be quoted on indents.

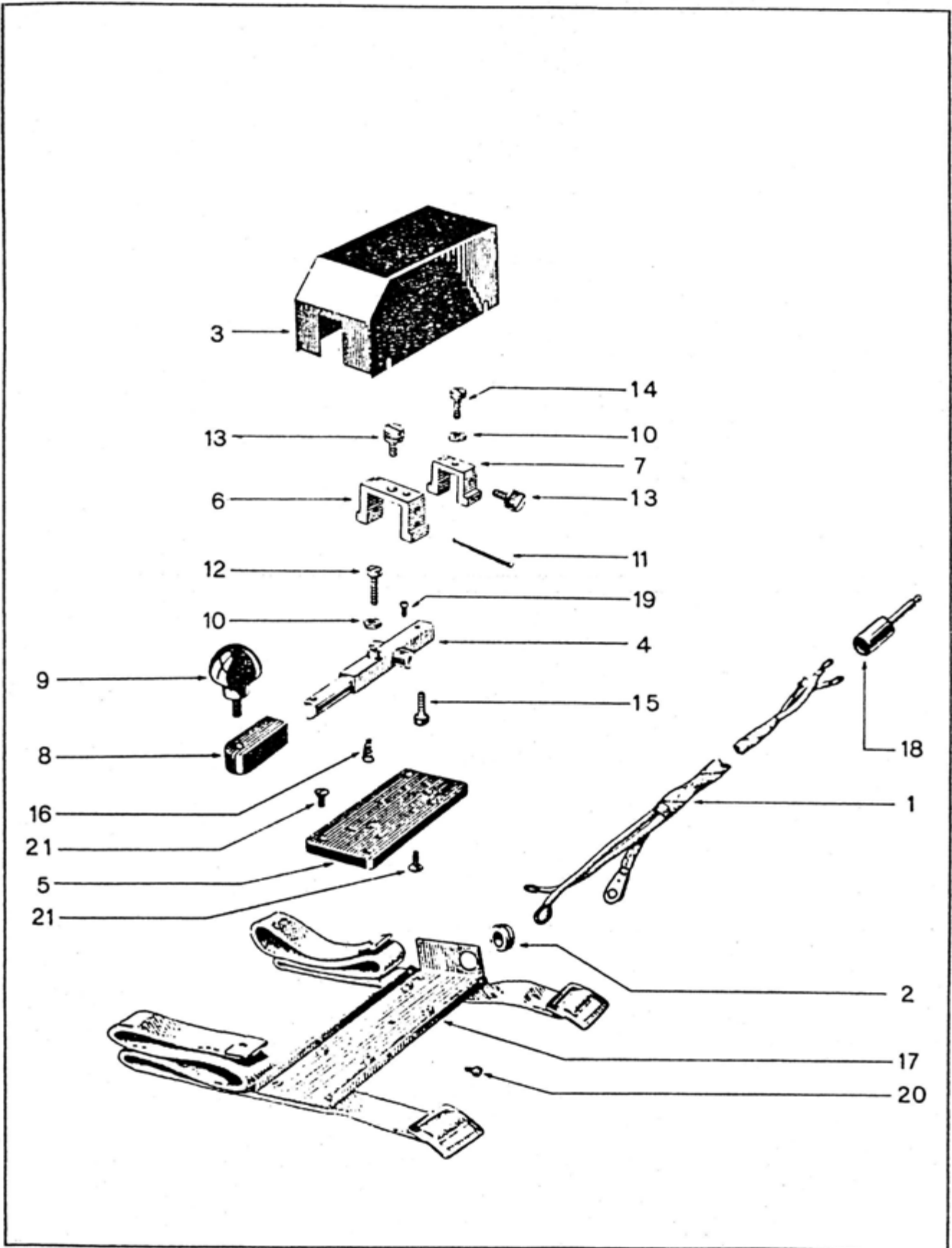

KEY AND PLUG ASSEMBLIES, CDN NO. 9 TYPE 1

Appendix 3 - 3.

Exploded view of Canadian Key and Plug Assembly No. 9, type 1, showing all components. Scan taken from Canadian EMERs FZ 256/2. See next page for designation and V.A.O.S. Numbers.

Det. No.	DESIGNATION	No. per illus.	V. A. O. S.		Manufacturers Number	Cir. Ref.	Repair Schedule			
			Sect.	Number			Unit	Echelon	1st	2nd
	KEY AND PLUG ASSEMBLIES CDN NO. 9, TYPE 1		21	ZA/CAN 1643	R 11950-1			R	R	R
1	● CORDS, 2-Core, 54-in.....	1	21	ZA/CAN 0979	[RCA 110113-1 PC 90691 C-11		X	X		R
2	GROMMETS, Rubber, 5/16-in. ID, 7/16-in. x 1/16-in. Panel.....	2	21	ZA/CAN 0984	X 4534-7					R
3	HOUSINGS, Metal, Key and Plug Assemblies, No. C1.....	1	21	ZA/CAN 0981	PC 90691 C-8					R
4	KEYS, W.T., 8-Amp., No. C4.....	1	21	ZA/CAN 1522	R 11950-2					R
5	BARS, Keys W.T. 8-Amp., No. C3.....	1	21	ZA/CAN 1648	R 11950-3					R
6	BASES, Phenolic, Keys W.T. 8-Amp., No. C1..	1	21	ZA/CAN 0986	PC 90691 C-13					R
7	BRACKETS, Centre, Keys W.T. 8-Amp., No. C2..	1	21	ZA/CAN 1647	R 11950-12					R
8	BRACKETS, End, Keys W.T. 8-Amp., No. C2....	1	21	ZA/CAN 1646	R 11950-13					R
9	GUARDS, Keys W.T. 8-Amp., No. C1.....	1	21	ZA/CAN 0991	PC 90691 C-20					R
10	KROBS, Keys W.T. 8-Amp., No. C1.....	1	21	ZA/CAN 0992	R 11950-17					R
11	NUTS, BA, Brass, Hex, No. 2, 0.114-in. thk.	2	22	ZB/CAN 1521	R 11737-2					R
12	PINS, Keys W.T. 8-Amp., No. C1.....	1	21	ZA/CAN 0993	PC 90691 C-23					R
13	SCREWS, Adjusting, Keys W.T. 8-Amp., No. C1	1	21	ZA/CAN 0984	PC 90691 C-21					R
14	SCREWS, BA, Brass, Ch H, No. 2 x 1/4-in....	2	22	ZB/CAN 2801	PC 30172 R 11724-4					R
15	SCREWS, Contact, Keys W.T. 8-Amp., No. C1..	1	21	ZA/CAN 0995	R 11950-6					R
16	SCREWS, Contact, Keys W.T. 8-Amp., No. C3..	1	21	ZA/CAN 5376	R 11950-7					R
17	SPRINGS, Helical, Keys W.T. 8-Amp., No. C1.	1	21	ZA/CAN 0997	PC 90691 C-22					R
18	PLATES, Metal, Adaptor, Key and Plug Assemblies, No. C3.....	1	21	ZA/CAN 1644	R 11950-10					R
19	PLUGS, Single, No. C1.....	1	21	ZA/CAN 0980	PC 90691 C-25					R
	MOUNTING HARDWARE									
19	SCREWS, BA, Steel, Ch H, No. 6 x 1/4-in....	1	22	ZB/CAN 2879	[PC 30092 R 11726-4					
20	● SCREWS, BA, Brass, Ch H, No. 6 x 3/16-in....	4	22	ZB/CAN 0620	R 11730-3					
21	● SCREWS, BA, Brass, Ch H, No. 4 x 3/8-in....	6	22	ZB/CAN 2614	R 11713-6					

● These items only are carried in Ordnance as Spares. Full designation and V.A.O.S number MUST be quoted on indents

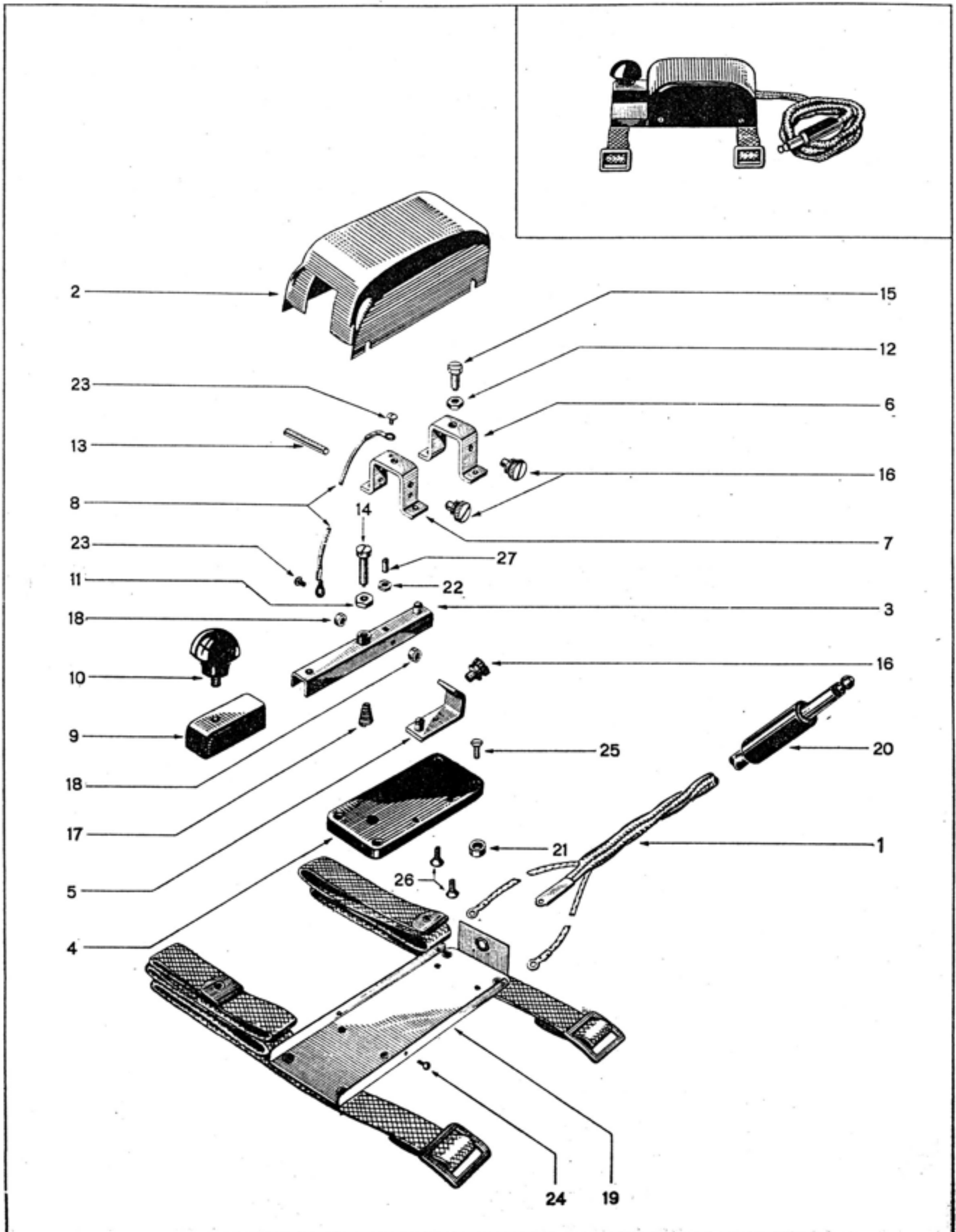

KEY AND PLUG ASSEMBLIES, CDN., NO. 9

Appendix 3 - 5.

Exploded view of Canadian Key and Plug Assembly No. 9, type 2 showing all components. Scan taken from Canadian EMERs FZ 256/3. See next page for designation and V.A.O.S. Numbers.

Det. No.	DESIGNATION	No. per Illus.	V. A. O. S.		Manufacturers Number	Cir. Ref.	Repair Schedule			
			Sect.	Number			Echelon			
							Unit	1st	2nd	4th
	<p>● KEY AND PLUG ASSEMBLIES, CDN, NO. 9, TYPE 2</p>		21	ZA/CAN 0715	RCA 110072-1		R	R	R	
1	CORDS, 2-Core, No. C3.....	1	21	ZA/CAN 0924			X	X	R	
2	HOUSINGS, Metal, Key & Plug Assemblies, No. C2.....	1	21	ZA/CAN 0925					R	
	KEYS, W/T, 8-Amp, No. C3.....	1	21	ZA/CAN 0926					R	
3	BARS, Keys W/T 8-Amp, No. C2.....	1	21	ZA/CAN 0961					R	
4	BASES, Phenolic, Keys W/T 8-Amp, No. C2....	1	21	ZA/CAN 0962					R	
5	BRACKETS, J-shape, Keys W/T 8-Amp, No. C1..	1	21	ZA/CAN 0965					R	
6	BRACKETS, Contact, Keys W/T 8-Amp, No. C1..	1	21	ZA/CAN 0963					R	
7	BRACKETS, Pivot, Keys W/T 8-Amp, No. C1....	1	21	ZA/CAN 0964					R	
8	CONNECTIONS, Flexible, Keys W/T 8-Amp, No. C2.....	1	21	ZA/CAN 0966					R	
9	GUARDS, Keys W/T 8-Amp, No. C2.....	1	21	ZA/CAN 0967					R	
10	KNOBS, Keys W/T 8-Amp, No. C2.....	1	21	ZA/CAN 0968					X	
11	NUTS, ANC, Brass, Hex, 8-32.....	1	22	ZB/CAN 3227	R 15016-7				R	
12	NUTS, ANF, Brass, Hex, 10-32.....	1	22	ZB/CAN 3240					R	
13	PINS, Keys W/T 8-Amp, No. C2.....	1	21	ZA/CAN 0973					R	
14	SCREWS, Adjusting, Keys W/T 8-Amp, No. C2..	1	21	ZA/CAN 0970					R	
15	SCREWS, Contact, Keys W/T 8-Amp, No. C2....	1	21	ZA/CAN 0971					R	
16	SCREWS, Terminal, Keys W/T 8-Amp, No. C2...	3	21	ZA/CAN 0972					R	
17	SPRINGS, Helical, Keys W/T 8-Amp, No. C2....	1	21	ZA/CAN 0974					R	
18	SPACERS, Metal, 1/4-in. OD, 9/64-in. ID, .113-in. long.....	2	21	ZA/CAN 0969					R	
19	PLATES, Metal, Adaptor, Key & Plug Assemblies, No. C2.....	1	21	ZA/CAN 0927					R	
20	PLUGS, Single, FL 55.....	1	21	ZA/CAN 0928	RCA 114063				R	
21	SPACERS, Brass, 5/16-in. OD, 3/16-in. ID, .124-in. long.....	4	21	ZA/CAN 0826					R	
	MOUNTING HARDWARE									
22	NUTS, ANF, Brass, Hex, 6-40, 1/4-in. af....		22	ZB/CAN 0923					R	
23	SCREWS, ANC, Brass, BH, 3-48 x 1/8-in.....		22	ZB/CAN 0883					R	
24	SCREWS, ANC, Steel, BH, 4-40 x 1/8-in.....		22	ZB/CAN 0748					R	
25	SCREWS, ANF, Steel, Csk H, 6-40 x 5/16-in..		22	ZB/CAN 0803					R	
26	SCREWS, ANF, Steel, Csk H, 6-40 x 3/8-in..		22	ZB/CAN 0829					R	
27	SCREWS, ANF, Steel, Grub, 6-40 x 1/4-in....		22	ZB/CAN 0917					R	

● These items only are carried in Ordnance as Spares. Full designation and V.A.O.S. number MUST be quoted on indents.

KEY AND PLUG ASSEMBLIES, Cdn, No. 9, Type 2

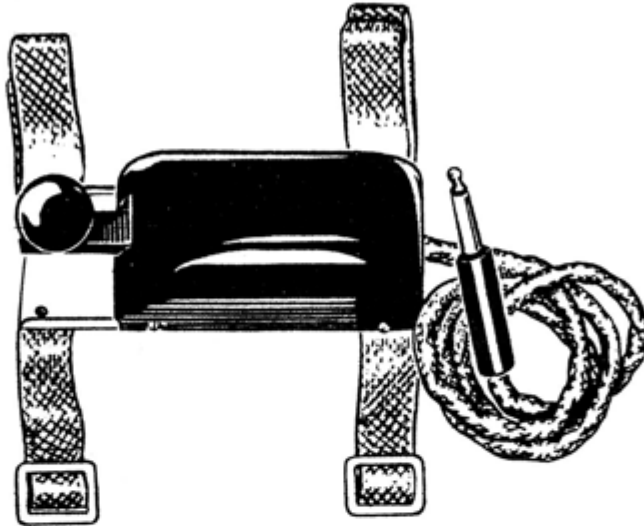

ZA/CAN 0715

MAINTENANCE SPARES LIST

DESIGNATION	No. USED	V.A.O.S.	
		SECT	NUMBER
CORDS, 2-Core, No.C3.....	1	Z1	ZA/CAN 0924
★ KEYS, WT, 8-Amp, No.C3.....	1	Z1	ZA/CAN 0926
KNOBS, Keys WT, 8-Amp, No.C2.....	1	Z1	ZA/CAN 0968
PLUGS, SINGLE, PL 55.....	1	Z1	ZA/CAN 0928
<p>★ This item was not supplied in Bulk Maintenance Spares for WS, Cdn, No.52, but may be found supplied as a spare on FULLERPHONES, Mk 4 & Mk 4/1, Cdn</p>			

Appendix 3 - 7.

General view and list of maintenance spares
Canadian Key and Plug Assembly No. 9, type 2.

KEY AND PLUG ASSEMBLIES, Cdn, No. 9, Type 2

CORDS, 2-Core, No. C3

5/16-in dia x 52-in lg; brown cotton braid
2-conductor cord; ends terminate in four small
terminal tags

ZA/CAN 0924

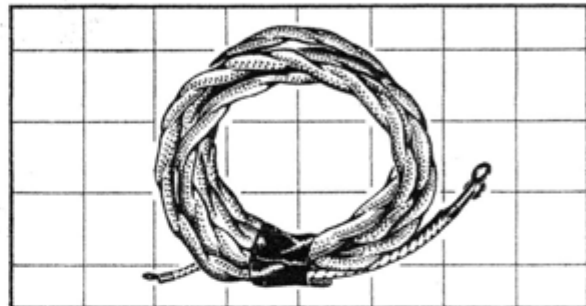

ZA/CAN 0924

KEYS, WT, 8-Amp, No. C3

4.7/8-in x 1.15/16-in x 1.19/32-in overall; black
phenolic plate 3.7/16-in x 1.19/32-in x 1/4-in;
four 1/8-in dia mtg holes on 3.1/16-in x 1.1/8-in
ctrs; two U-shaped bkts 1.7/16-in x 1-in x 15/32-
in; J-shaped bkt 1.1/4-in x 7/8-in x 15/32-in;
1.1/16-in max dia x 1-in lg black phenolic knob
(ZA/CAN 0968) & hollow case 1.19/32-in x 21/32-in
x 9/16-in mtd on metal bar 3.13/16-in lg; bkts
fitted w/adj contact & terminal screws; braided
flex connector from pivot bkt to bar; may be
stamped "WESTCLOX"

ZA/CAN 0926

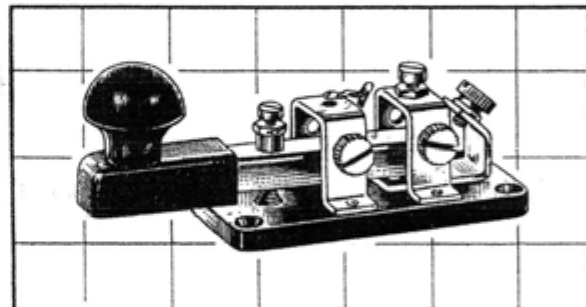

ZA/CAN 0926

KNOBS, Keys WT 8-Amp, No. C2

1.1/16-in max dia x 1.5/16-in lg; 1-in lg black
phenolic knob tapering from 1.1/16-in max dia to
9/16-in dia at bottom; brass insert thd ANC 10-32
projects 5/16-in from bottom

ZA/CAN 0968

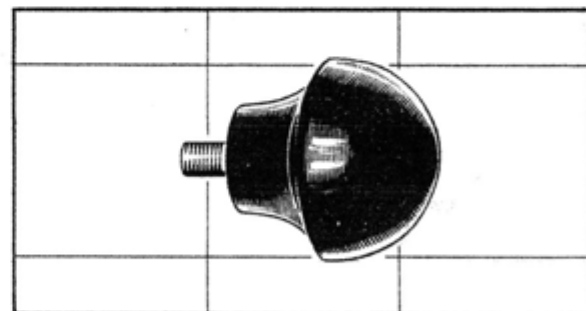

ZA/CAN 0968

PLUGS, Single, PL 55

1/2-in max dia x 2.27/32-in lg overall; brass
sleeve & tip 1/4-in max dia x 1.7/32-in lg
insulated from each other by black phenolic
washer; terminals housed in black phenolic
screw-on cover 1/2-in OD x 1.5/8-in lg; cover
stencilled "PL-55"

ZA/CAN 0928

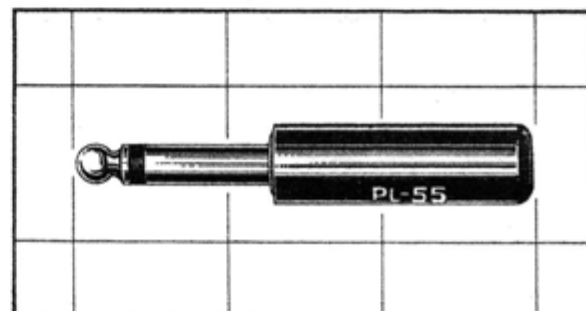

ZA/CAN 0928

Appendix 3 - 8.

General view and list of maintenance spares
Canadian Key and Plug Assembly No. 9, type 2.

- Key and Plug Assembly No. 9, by Alex Vilensky 4X1MH, *Morsum Magnificat* 13, Autumn 1989.
- The Ubiquitous Key WT 8 Amp, by Jim Lycett G0MSZ, *Morsum Magnificat* 22, Spring 1992.
- Key WT 8 Amp Worldwide Survey Results, by Tony Smith G4FAI, *Morsum Magnificat* 28, June 1993.
- Unusual Military Morse Keys, by Louis Meulstee PA0PCR, *The AWA Review*. 8, 1993.
- Key WT 8 Amp, Further Information, by Tony Smith G4FAI, *Morsum Magnificat* 37, Christmas 1994.
- Keys for the Wireless Set No. 19 (Canada and USA), by Chris Bisailion VE3CBK, *Morsum Magnificat* 45, April 1996.
- Key WT 8 Amp, Final Instalment, by Tony Smith G4FAI, *Morsum Magnificat* 50, February 1997.
- Archeological Unwrapping of a Key and Plug Assembly No. 9, by Chris Bisailion VE3CBK, *Morsum Magnificat* 64, July 1999.
- Key WT 8 Amp No. 2 - Specification, by Tony Smith G4FAI, *Morsum Magnificat* 77, September 2001.

Appendix 4: Recommended further reading.

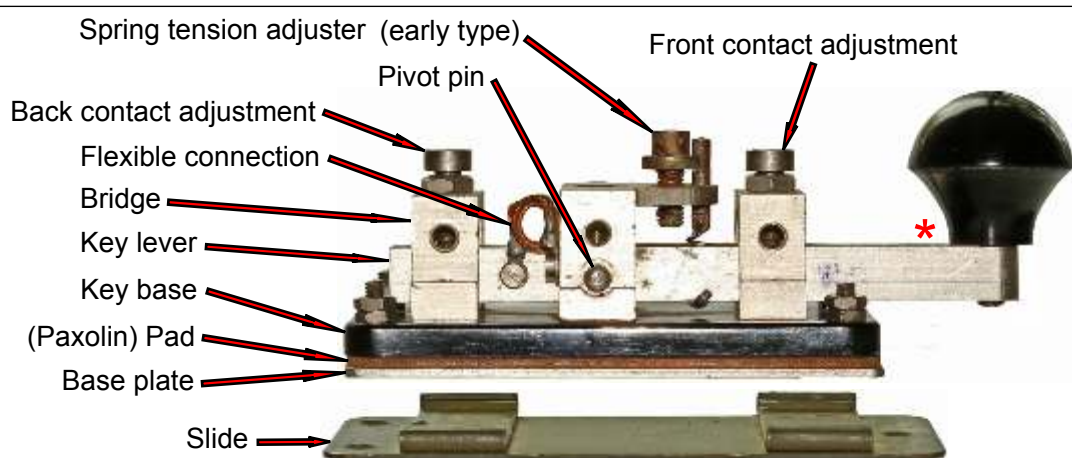

* The finger rest, normally fitted below the key knob, is missing from this key.

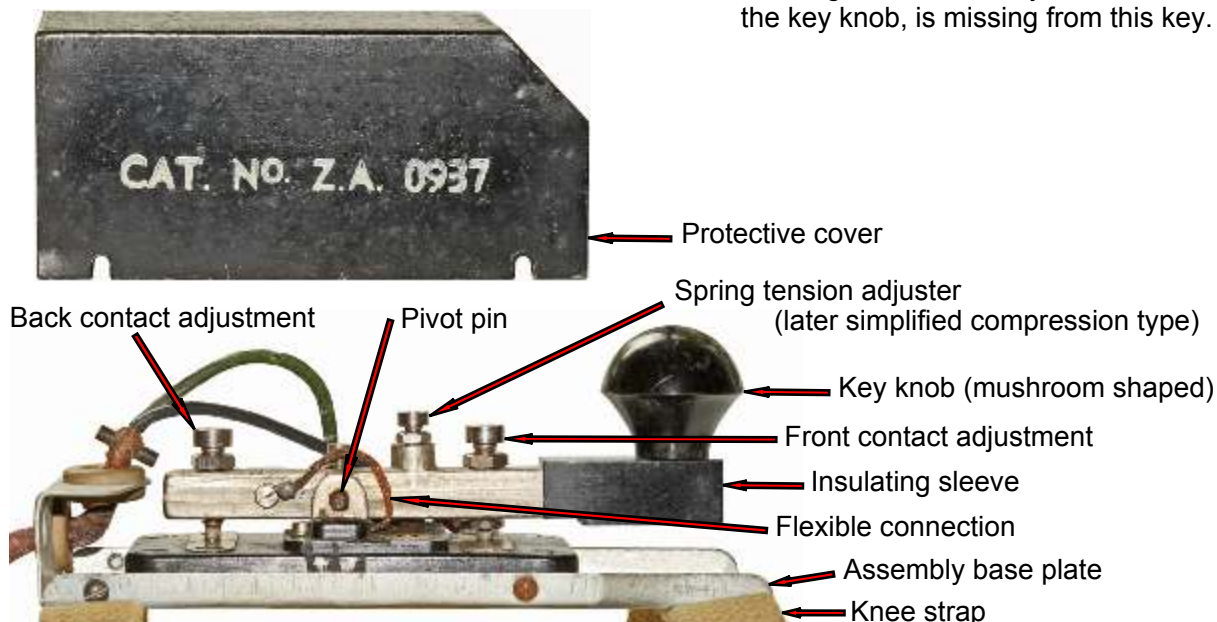

Appendix 5: Key and Plug Assembly definitions

To avoid confusion in the correct designation of various parts of the Key and Plug Assemblies, definitions of the most common encountered items are provided. Although some may be named differently in literature and manuals, they are considered as the most suitable and commonly used.

About the Wireless for the Warrior books.

The Wireless for the Warrior range of books (comprising the **Volume** and **Compendium** series) are intended as source of reference to the history and development of radio communication equipment used by the British Army from the very early days of wireless up to the 1960s. Line equipment and military radio communication equipment from other countries is also covered in the recently published Compendiums.

The WftW **VOLUME** Series

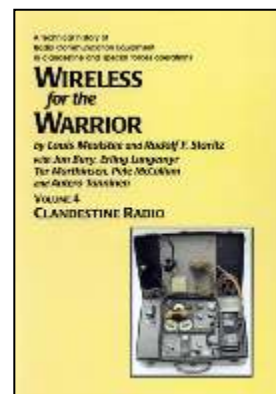
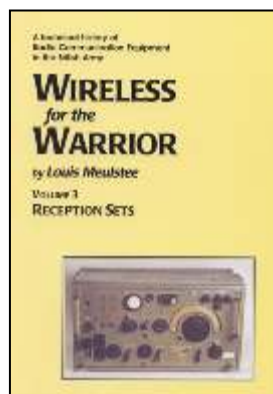
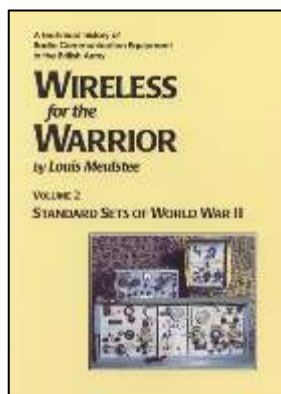
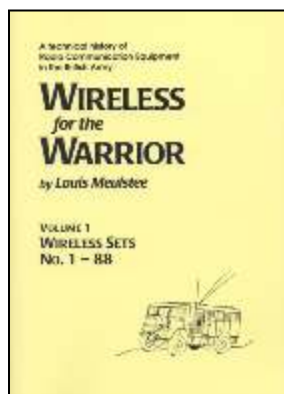

The books in the WftW **Volume** series are very detailed and include circuit diagrams, technical specifications and alignment data in addition to technical development history, complete station lists and vehicle fitting instructions. Generally no operational histories are given as these have been published extensively in numerous other books.

The WftW **COMPENDIUM** Series

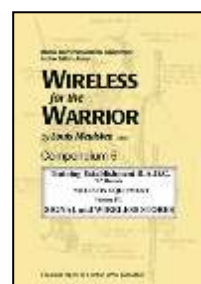
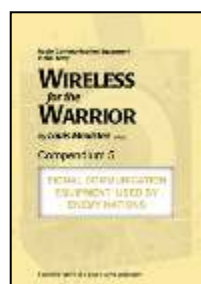
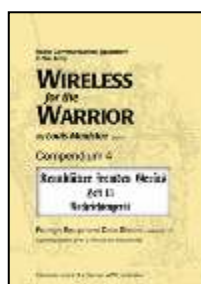
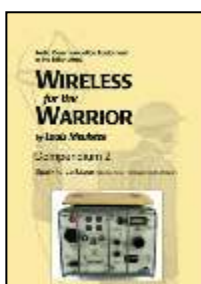
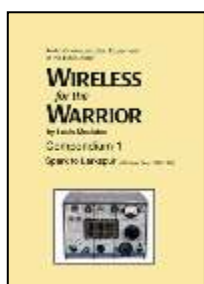

The WftW **Compendium** series is a new addition to the Wireless for the Warrior range, currently comprising 6 books. The new series is principally intended as practical guide and reference source to vintage military signal communication equipment. The books are particularly valuable to anyone with an interest, professionally or otherwise, in this subject, requiring an elementary but complete quick reference and recognition handbook. Containing condensed data summaries, liberally illustrated with photos and drawings, explanatory captions and short description of the main ancillaries, its pocket size format and laminated soft cover makes it an ideal reference and reliable companion for events such as auctions and radio rallies, or just for browsing at leisure.

Wireless for the Warrior **Volumes 1-4** and **Compendium 1** are available by mail order from Wimborne Publishing Ltd. Wireless for the Warrior **Compendiums 2-6** are only available direct from the Print On Demand printing company via the Internet WftW bookshop at <http://www.lulu.com/spotlight/wftw> Print On Demand is a printing technology in which new copies of a book are not printed until an order has been received, which means books can be printed one at a time. Each order is printed and shipped locally, which reduces delivery time and shipping costs. For more information and up-to-date news about developments in the Wireless for the Warrior range of books and a link to the Wimborne Ltd website visit the Wireless for the Warrior website <http://www.wftw.nl>