

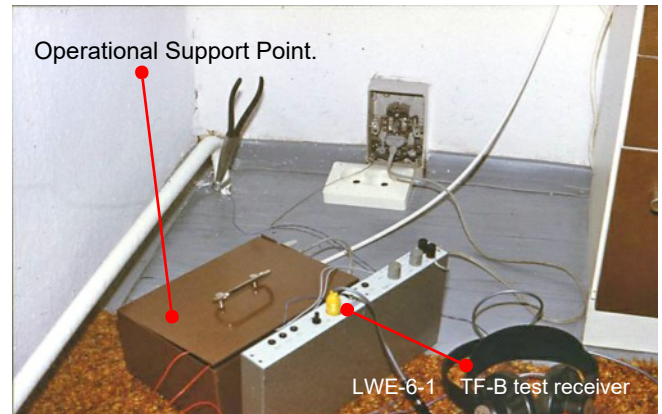

TF-B tx (2D) transmitter

TF-B (2D) system: Preparation and installation of a microphone through a small hole in the wall to the adjacent (to be intercepted) apartment known as Operational Object. Note the TF-B tx transmitter (2D) unit and a (black) battery which were placed in a neighbouring apartment. The transmission to the TF-B rx receiver in the Operational Support Point (photo right) was via the central heating pipe and earth.



Operational Support Point.

LWE-6-1 TF-B test receiver

Connecting a LWE-6-1 TF-B test receiver to an AC mains power point in a Operational Support Point located at the top apartment of the same block as the Operational Object. The Operational Support Point was fitted in a metal cassette (behind the test receiver) comprising a 31140 TF-B rx receiver and a 31121 TF-tx transmitter, the latter connected to a telephone subscriber line. From this point the intercepted audio was routed to the CEKO system.

Introduction to line based bugs. Country of origin: GDR

Preceded by an abridged section on the CEKO system

Though chapters in the WftW Volume 4 Supplement seldom exceed more than 2 pages, it was felt to make an exception with this introduction chapter on the rather diverse line based bugs and the essential functions of the co-ordinate CEKO system. The basic idea about putting together this rather complicated chapter was to show, in some detail, the path between the overhearing device to central automatic recording in a district CEKO.

The CEKO system, an abridged introduction.

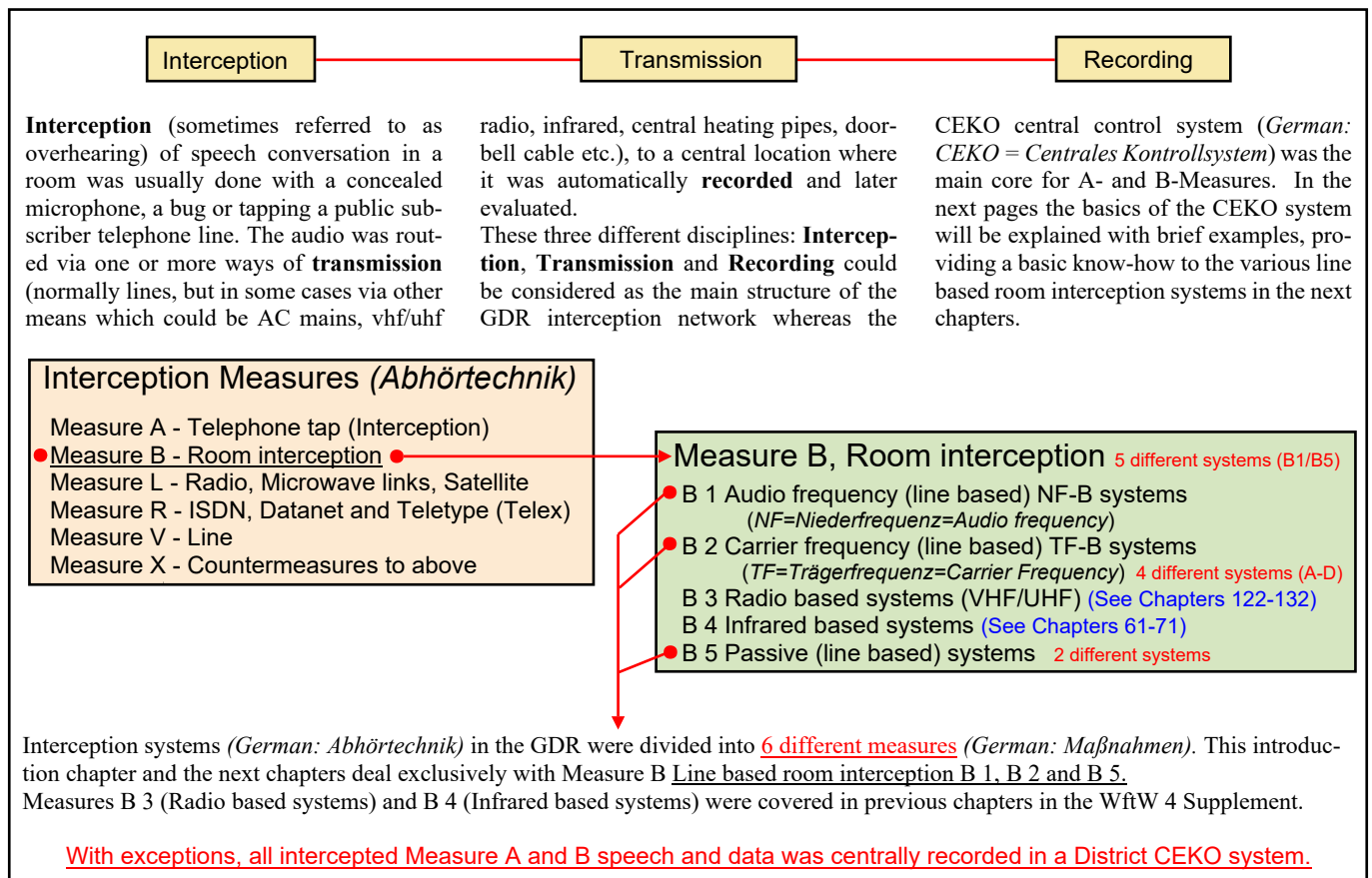

The CEKO system

The GDR was divided into 15 Districts (*Bezirke*) (e.g. Berlin was a district) each with an administrative MfS (*Ministerium für Staatssicherheit / Stasi*) District Office (*Bezirkverwaltung*). Each District was divided in a number of Areas (*Kreisen*) with MfS Area Offices (*Kreisdienststellen*); 209 in total plus 7 Site offices. (Depending on a district, this ranged from 8 to 24 Area Offices per District)

Recording of the Measure A (public subscriber telephone tap) and Measure B (room interception) speech conversation was done centrally in the MfS District Office, with exceptions. Located in a District office was the District CEKO.

The CEKO system, comprising one District CEKO and a number of Area CEKO systems was set up in a star form, similar to a telephone network, interwoven in the civil Deutsche Post telephone network, at that time still electro-mechanical with many components still dating back to the 1920s. The CEKO equipment was designed by

MfS OTS Abt. 33, starting in 1965 and gradually being introduced from 1973 onwards with a maximum capacity of 4900 so-called controlled units (*KE=Kontrolleingänge*) for all Measure A and B together, and a further 1500 local units (known as *Einzelaufgaben*). It was operated and maintained by MfS Abt. 26. About 80% of the controlled units were Measure A, and 20% Measure B. Line taps made in the public telephone network were about 70% in the local Deutsche Post telephone exchange, 10% in a line branch and 20% in the feeder or subscriber distribution

interface (see example 1 on page 6 in this chapter). The actual taps were usually made by so-called IM's (*German: IM= Informelle Mitarbeiter*), unofficial MfS employees recruited (willingly or not) from the Deutsche Post.

Before the introduction of CEKO systems, MfS Abt. 'O' had started in 1956 development for a decentralised telephone interception network known as 'System A', which went into operation in the early 1960s. These systems (27) were used e.g. in Berlin and Leipzig, with a total of about 200 tapped public telephones.

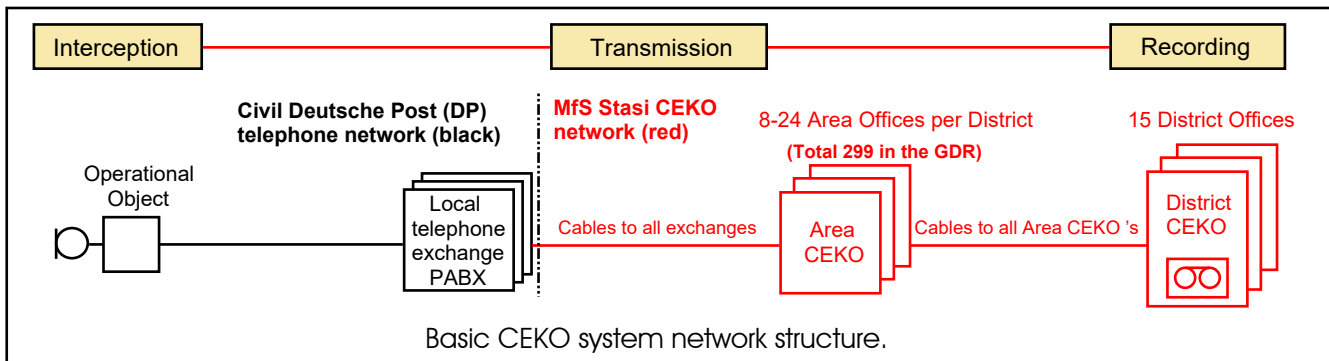

The District CEKO in a MfS Stasi District Office was connected by cables to all the MfS Area offices where the (usually unmanned) Area CEKO system with distribution frames connecting to Deutsche Post telephone exchanges and other distribution facilities, for example leased Post Office

lines. Nearby Operational Objects were directly connected to the Area or District CEKO. In the District CEKO room were distribution frames, control equipment and compact cassette tape recorders in recorder frames. (MTG German: *Magnettonerätgestell*).

In addition ancillary equipment such as control desks for listening in at current conversations, and evaluation desks where recorded speech was evaluated. The CEKO system was based on KME3 hybrid circuits and transistor technology.

Definitions:

- 1) The location of a bug, concealed microphone or tapped telephone was known as Operational Object.
- 2) An Operational Support Point, was used when no direct connection of a Measure B Operational Object to an Area or District CEKO could be arranged.
- 3) An Operational Object to the Operational Support Point formed the 1st Subsystem.

DATA SUMMARY

Organisation: MfS, Abt. 26.¹⁾
Design/manufacture: MfS, OTS, Abt. 33.
Year of Introduction: 1960s...1989.
Purpose: Transmission and central recording system of tapped subscriber telephones and concealed room interception line based interception systems over existing lines, AC mains, doorbell cable, telephone lines, etc. confined to Measures A and B.

¹⁾ Ministry of Security, Department 26, 'Telefon- und Fernschreib überwachung, akustische und optische Raumüberwachung'. (Telephone and telex interception, acoustical and optical room interception).

References:

- With thanks to Detlev Vreisleben, DC7KG, Germany for permission to use excellent photographs and scans, and providing all the technical and historical information. Without Detlev this series on GDR bugs would not have been possible.
- Photos of CEKO room in Chemnitz taken by Michael Backhaus.
- Much of the technical information used for the condensed description of the CEKO system was based on 'The Telephone Interception system of the Stasi', a manuscript written by Detlev Vreisleben, published in the 'Enigma 2000' Newsletter No. 87, March 2015.
- *Hinweise zur Lichtnetztechnik*, (Notes for AC mains systems), Information 7/88, Aufgabe B, MfS, Abt. 26/4, August 1988.

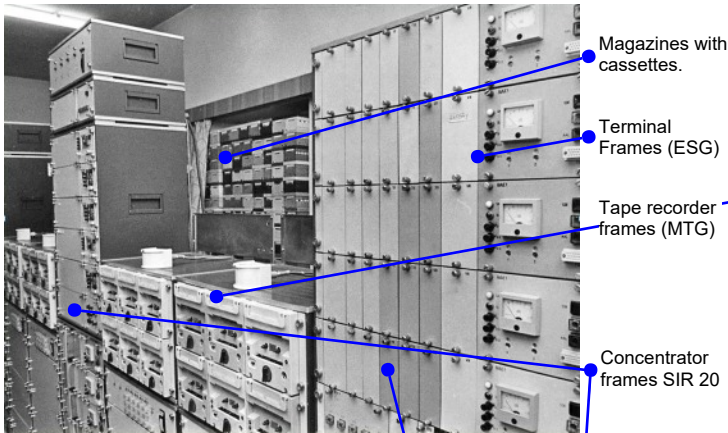

District CEKO room in MfS (Stasi) District office Karl Marx Stadt (Chemnitz). The MTG frames in this photo had 6 type CAG-A compact cassette recorders in parallel operation configuration.

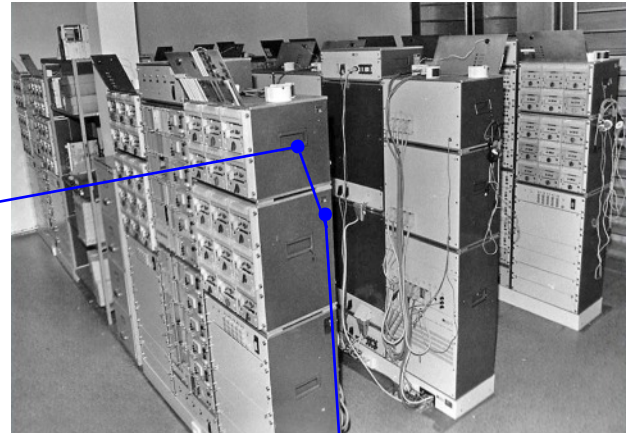

District CEKO room in MfS (Stasi) District office Karl Marx Stadt (Chemnitz). Note MTG frames with 15 (6 and 9) type CAG-A compact cassette recorders in series-parallel configuration.

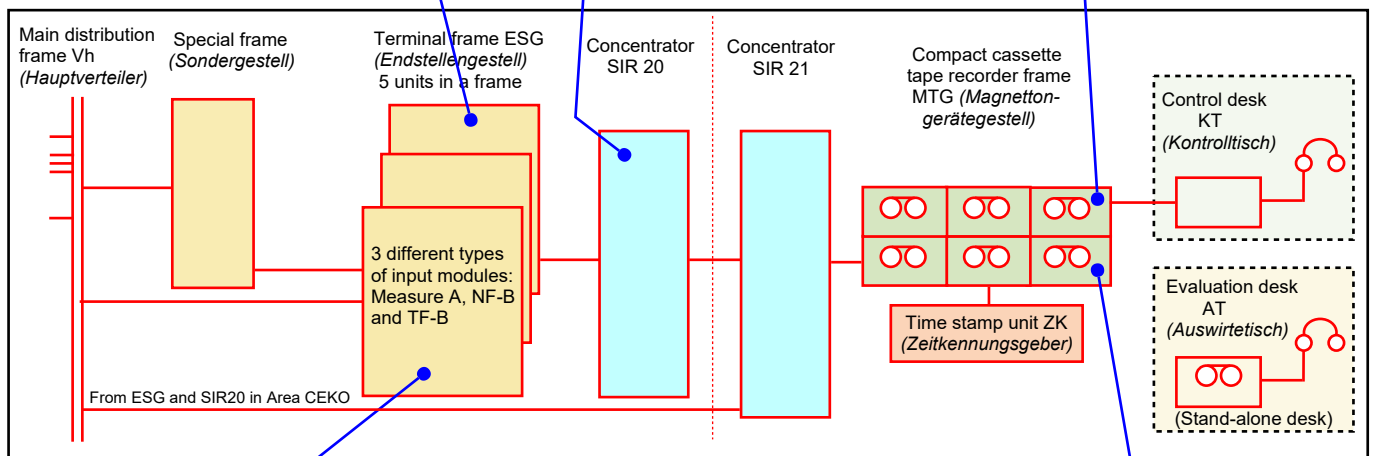

Simplified block diagram of equipment in a District CEKO

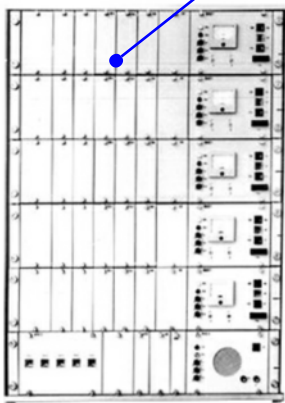

Terminal frame ESG with 5 ESG units. The loudspeaker below was for signalling only.



MTG tape recorder frame with 5+1 CAG-A compact cassette recorders for 5 Operational Objects plus one spare.

The very simplified block diagram of the equipment in a District CEKO above shows the most important and essential components of the system.

The Terminal Frame ESG (*German = Endstellengestell*) can be considered as the heart of the CEKO along with the compact cassette tape recorder frame MTG (*German = Magnetton-gerätegestell*).

There were normally 5 ESG units in an ESG terminal frame, and 6 CAG compact cassette recorders (5+1 spare) in a MTG frame giving 30 minutes of recording time.

For each Operational Object was an ESG and CAG. In the Special Frame (*German = Sondergestell*) of an area or district CEKO, the Carrier Frequency signals (24, 40 or 104kHz) which came direct from an Measure B (2 A-D) Operational Object were converted to 55, 70 or 85kHz, similar to those from an Operational Support Point and routed to the Terminal Frame ESG.

Operational Support Points were connected directly to the Terminal Frame ESG. The latter had three different types of input modules: for Measure A, Measure B AF and

Measure B TF. The outputs of the ESG units were connected via concentrators SIR20 and SIR 21 to the tape recorder frame MTG.

The Area CEKO installations had pre-arranged frames for fitting Special Frames, ESG units and Concentrators SIR 20 as required. An Area CEKO SIR 20 was connected to an SIR 21 in the District CEKO via a multi channel or PCM frame.

In conclusion:

The structure of all the different Measure A and particularly Measure B systems was rather complex. The (technical) difficulties in routing a bug or tapped telephone from an Operational Object to a District CEKO could differ considerably from case to case.

The CEKO system was consequently designed to be versatile and flexible, and could fulfil almost any requirement, but was as a

result rather complicated. CEKO was designed so that in total 4000 telephone numbers could be intercepted in the district offices, and 1500 locally (e.g. in mobile bases).

In Berlin, there was a capacity of 1100 (880 tapped telephones and 220 bugs). In total, about 0.3% of the 1.8 million phone lines in the GDR could be monitored.

After the fall of the Berlin wall in 1989, the entire CEKO technology/equipment was destroyed except for only a few components. The museum in the "Runden Ecke" (Round Corner), a previous MfS Stasi building in Leipzig, has an AT 2 (evaluation unit), and the connection to a recording frame in their collection.

Tape recorders

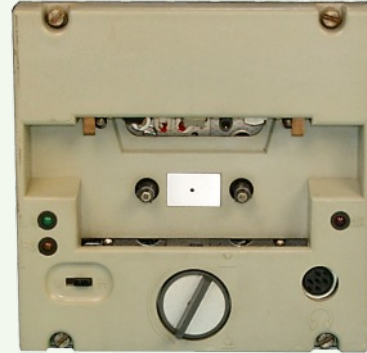
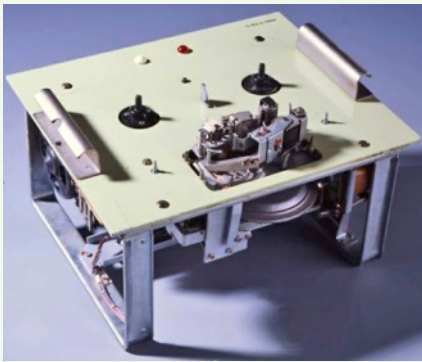

Jesenik tape recorder (left) and Hostyn playback machine (right). The reel-to-reel tape in a cassette allowed rapid change and vertical positioning of a stack of recording machines.

CAG-A (German A = Aufnahme = recording) compact cassette recorder for rack mounting which was used for recording intercepted messages after 1980 (above) and successor CAW-E (German E = Einschub = plug-in to EGS-System). (below)

The actual recording of intercepted messages in the District CEKO was initially with Czech type Jesenik (TI-613-2) and Hostyn (TI-612) playback reel-to-reel tape recorders, which were specifically designed for this purpose.

These recorders were mounted vertically one above another and used a cassette which allowed the tapes to be changed quickly. The recording time of a tape was 90 minutes.

The Jesenik tape recorders were probably so troublesome that it was decided to develop and produce recorders in the GDR, based on the compact cassette concept.

In the early 80s CEKO was modernised with compact cassette recorders, as well as a new direct control system, renamed CEKO 2, maintaining similar basic functions. The service life for CEKO 2 was intended to extend up to the 2nd half of the 90s. The CAG-A and later compact cassette tape recorders were produced by VEB Elektronik Gera. (VEB = Volkseigener

Betrieb = People's owned company). Evaluation desks, where the recorded tapes were listened to and the stored information (date, time and number dialled) was evaluated, used different models of compact cassette players e.g. type CAW-W. In 1989, at the unification of East and West Germany, the MfS possessed over 12,000 recording devices.

A cassette tape recorder frame MTG could be set up in parallel or series-parallel operation:

- In parallel operation 6 recording devices (cassette recorders) e.g. type CAG-A were assigned to five operational objects, the 6th unit was kept as a reserve in case one of the 5 failed or was fully recorded. 60 min cassettes were used which were recorded only on one side, giving 30 min recording time.

- In series-parallel operation 15 recording devices (compact cassette recorders) were assigned to five tapped telephone numbers, for every monitored Operational Object 3 x 30 min recording periods were available. A spare device was omitted, because in case

of failure another one of the 3 devices could be used. Series-parallel operation was primary used with Measure-B as conversations were usually longer.



Reel-to-reel tape recorders used with the CEKO predecessor 'System A' were the BG-31 made by VEB Meßgerätekwerk Zwoenitz (left) and the West German Uher 5000 (right).



Evaluation desk



Earlier evaluation desk equipment CWG (Cassette Wiedergabegerät = cassette playback unit) and an AT2 evaluation unit (below).

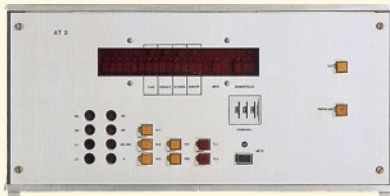

Evaluation equipment with a single cassette deck CAW-W (German W = Wiedergabe = playback) and AT3 evaluation unit (left).

Recorded and accurately numbered compact cassettes were stored in racks holding 20 cassettes until being evaluated. Track 1 of the cassette recorded the conversation and on track 2, date, time and the dialled number were recorded. The subscriber number of a caller to the monitored telephone could not be recorded with this system. The cassettes were listened to at an evaluation desk (German: *Auswertetisch*) equipped with e.g. type CAW-W cassette players, and if required, a written record was made. On a display in the AT2 or AT3 evaluation unit the date and time of the call was displayed. If the monitored subscriber was dialling out, the number would also be displayed. After evaluation the cassettes were erased, rewound and available for use again.

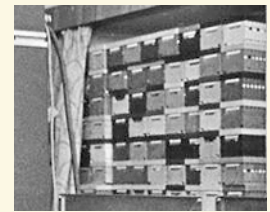

Compact cassette storage in a District CEKO.



The compact cassettes were stored in racks holding 20 units.



Cassette erase and rewind unit CAG-U (German U = Umspül und Löscherät)

Operational Support Point.



Example of an Operational Support Point fitted in a metal cassette arranged for supporting two different Operational Objects to the CEKO system. In this example it comprised two TF-B rx receivers 31140, an AC mains power unit, and two 31121 TF tx units.

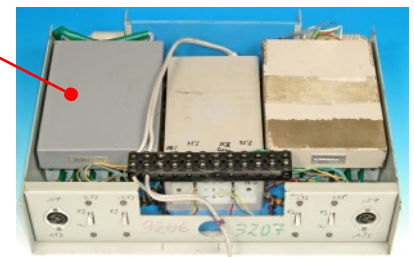
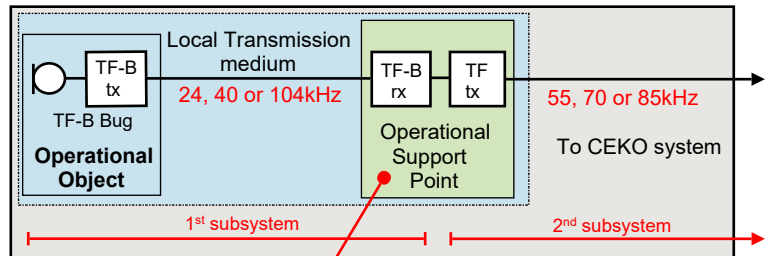

When the distance of a Measure B Operational Object to the Area or District CEKO was too long for reliable recording, or the use of Measure B 2 A (AC mains based) or B 2 C (doorbell cable based), an Operational Support Point (German = *Operative Stützpunkt*) was installed. This was principally a form of repeater. Depending on the situation, an Operational Support Point could be located in any suitable but trusted location and exceptionally in a telephone exchange (installed in a separate locked room).

The part from the Operational Object to an TF-B rx in the Operational Support Point was the 1st subsystem; from the TF tx to the CEKO system the 2nd subsystem. The carrier frequencies of the first sub-system (TF-B tx to TF-B rx: 24, 40 or 104kHz) differed from those of the second sub system (TF-tx to CEKO: 55, 70 or 85kHz), as they would interfere with each other. As the Terminal frame ESG at the CEKO was only capable to receive and demodulate the TF tx line transmitters, conversion took place in an Operational

Support Point. Otherwise if an Operational Object with TF-tx was directly connected to a CEKO, the TF-B frequencies were converted in the Special Frame (German: *Sondergestell*), which was principally a conversion unit; from there routed to the ESG. Note that besides the name there were other significant differences between a TF-B tx at an Operational Object and TF tx in an Operational Support Point, of which the different carrier frequencies were the most important.

Examples of routing an Operational Object to a District CEKO in Measure A and Measure B (2B).

In example 1 the audio from the intercepted telephone was tapped and routed to a CEKO via a leased line whereas in example 2 an TF-B tx FM carrier frequency was superposed on a subscriber telephone line. It should be noted that the very simplified block diagrams reflects just the most basic situation when the length of the line allowed this, without going into detail. In the diagrams no mention was made for additional equipment, and situations where no direct lines were available.

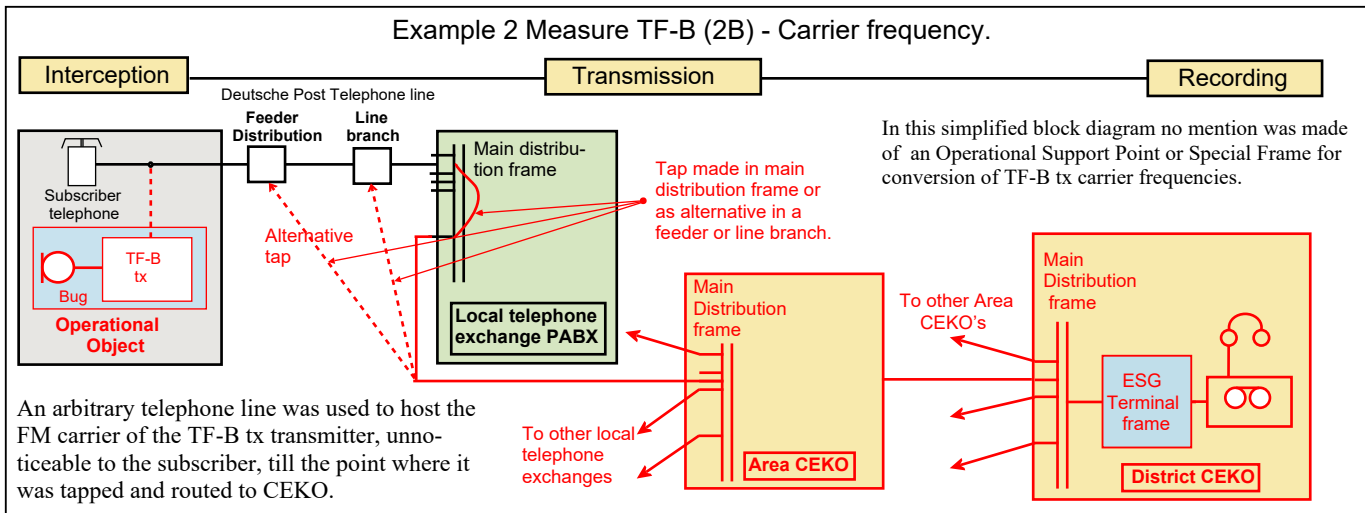
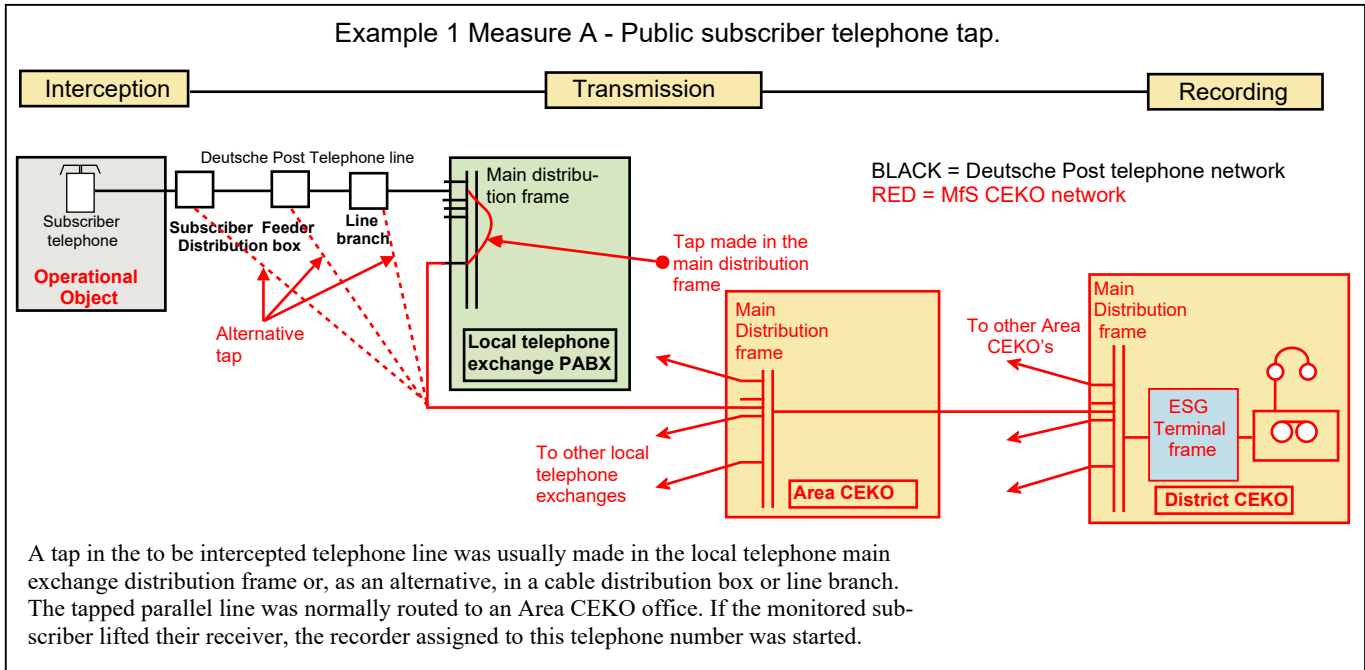

Line based bugs, a short introduction.

Attention:

In order to simplify the introduction of the actual intercept systems (bugs and concealed microphones, described in individual short chapters) it should be assumed that each of the Measure TF-B 1, B 2 and B 5 Operational Objects for room interception described below, the transmission routing to the District CEKO was omitted. In some cases, when technically required, an Operational Support Point was added.

- The individual numbering and sub-dividing of Measure B systems, e.g. TF-B (2A) was a personal addition for ease of identification -

NF-B 1 Audio Frequency line based systems. (NF=Niederfrequenz=Audio frequency)

A concealed microphone and associated amplifier were directly connected to the line or a TF tx and routed to CEKO. This was a straightforward system, primarily used in buildings which had already been permanently wired for this purpose. It was employed in e.g. prisons and hotels.

Described in Chapter 164

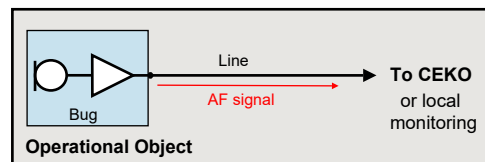

TF-B 2 Carrier Frequency line based TF-B systems. (TF=Trägerfrequenz=Carrier Frequency)

The TF-B systems were based on one pre-assigned FM carrier in a group of three frequencies in the range of 24kHz to 104kHz, which could not easily be intercepted. Operationally they were divided in four technically different groups, basically operating on the same principle, but using very different types of transmission media: AC mains, a subscriber telephone line, a doorbell/door opener cable, any available line or specially formed line.

Power for the Operational Object TF-B transmitter was derived from the actual transmission medium: 220V AC, 48V DC, 12V AC, or DC from the Operational Support Point. In some cases a separate AC mains power unit was located at the Operational Object. A concealed microphone and associated TF-B tx transmitter (the actual bug of which the microphone was usually separated from the transmitter unit) at the Op-

erational Object was connected to one of the four possible local transmission media, basically all with a similar circuit but a different matching interface. At the Operational Support Point at the other side was a TF-B rx receiver which had also a matching interface. Up to three TF-B tx systems, operating on different carrier frequency channels, could be combined on a single 2nd subsystem transmission line to a CEKO system.

Four different TF-B groups:

- TF-B (2A) AC Mains. (German = Lichtnetz Technik)
- TF-B (2B) Telephone subscriber line. (German = Telephone Technik)
- TF-B (2C) 12V AC door-bell cable. (German = 12V Technik)
- TF-B (2D) 2 wire line.

The names for the four groups in the TF-B carrier frequency line based system were derived from the transmission medium which was used to connect the bug (TF-B tx transmitter at the Operational Object) to the TF-B rx receiver at the Operational Support Point.

TF-B (2A) AC mains (Lichtnetz technik)

220 V AC mains (phase/neutral or phase/earth) in a building or apartment complex was used as transmission medium. The range of this system was limited to the local AC mains group.

Described in Chapters 165/166/167

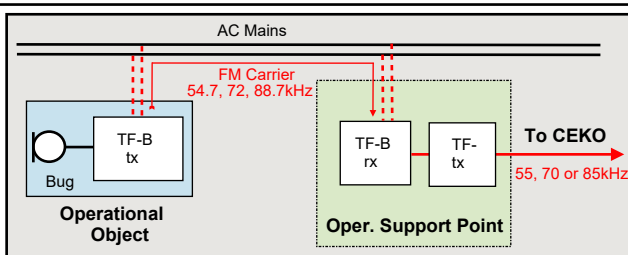

TF-B (2B) Subscriber telephone (Telephone technik)

In this system the standard telephone subscriber line of the intercepted location was used as transmission medium. The actual bug was often concealed in a telephone terminal block.

Described in Chapter 168-170

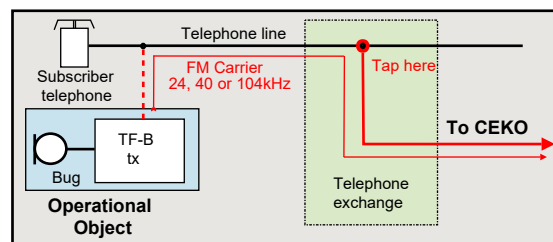

TF-B 2 C 12V doorbell (12V technik)

The 12V AC door bell cable was used to connect a TF-B tx transmitter at the Operational Object to the TF-B rx receiver at an Operational Support Point.

Described in Chapter 171

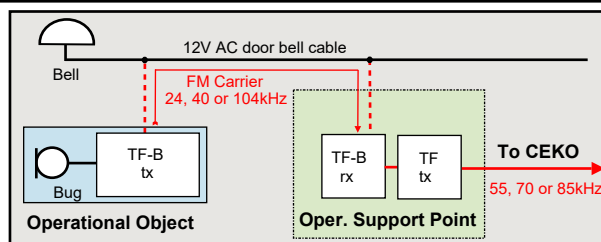

TF-B (2D) 2 wire line based TF-B systems

This was a general purpose carrier line system providing inconspicuous transmission over a line. It was basically similar to systems B 2 A/B 2 C. 12V DC for powering the TF-B transmitter was provided by the Operational Support point or from a separate power unit at the Operational Object depending whether the line was used for other purposes. *This could be any galvanic connection such as a central heating pipe.

Described in Chapter 172

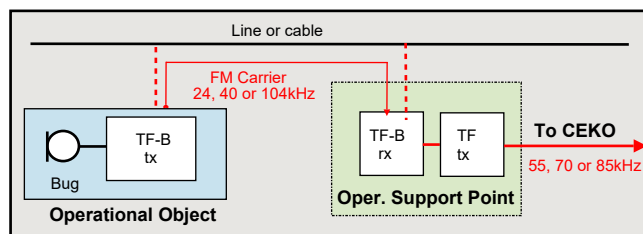

TF-B 5 Passive line based TF-B systems

Concealed bug operating on 60kHz which could be used on any existing line or transmission medium. It was activated when a 30kHz carrier was received. Power for the TF-B transmitter was derived from the up going carrier.

Described in Chapter 173

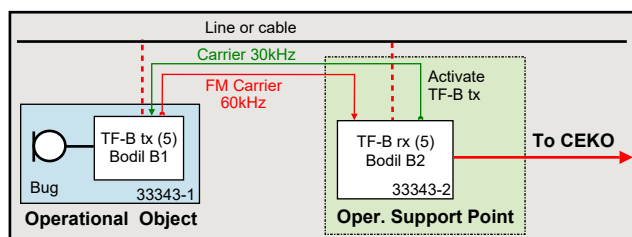

List of abbreviations and translations into English

- KVz Feeder distribution. German = *Kabelverzweiger*.
- HVt Main distribution frame. German = *Hauptverteiler*.
- PABX Local telephone exchange. German = *OVSt Ortsvermittlungsstelle*.
- LVZ Line branch. German = *Linienverzweiger*.
- OTS Technical Operational Branch. *Operativ Technischer Sektor*.
- CEKO Central control system. German CEKO = *Centrales Kontrollsystem*.
- TF Carrier Frequency. German = *Träger Frequenz*.
- IM Unofficial MfS employees. German = *Informelle Mitarbeiter*.
- ESG Terminal Frame. German = *Endstellengestell*.
- Vh Main distribution frame. German = *Hauptverteiler*.
- MTG Cassette tape recorder frame. German = *Magnetton-gerätegestell*.
- CAG Compact cassette recorder for rack mounting. German = *Cassette Aufnahmegerät*.
- VEB People's owned company. German = *Volkseigener Betrieb*.
- MfS Ministry of security. German = *Ministerium für Staatssicherheit*.
- Abt Department. German = *Abteilung*.
- KE Controlled units. German = *Kontrolleingänge*.
- OG Operational Area (usually FRG). German = *Operationsgebiet*.
- FRG Federal Republic of Germany. German = *Bundesrepublik Deutschland, BRD*.
- GDR German Democratic Republic. German = *Deutsche Demokratische Republik, DDR*.

Completeness and correct information.

Already mentioned in the previous pages of this introduction was the thorough dismantling and destruction of the overhearing systems, and associated documents during the unification of Germany. This introduction chapter was based on documents, illustrations and equipment that survived, now in custody in various German institutes and museums. Detlev Vreisleben's long standing tireless research unveiled material which was the sole source of this introduction, and the individual chapters on GDR line-, wireless- and infrared based bugs.

With this in mind, the 'WftW Volume 4 Supplement' chapters on overhearing techniques in the GDR is not complete, but still provides a very good overview of the achievements in the GDR, from a technical point of view.

Appendix 1

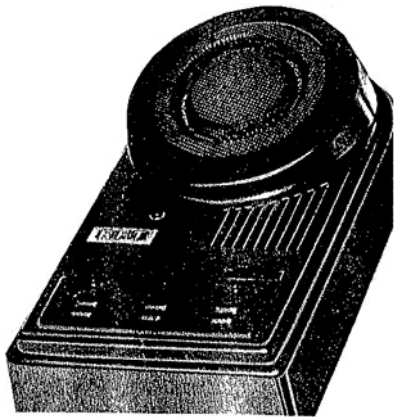

AC mains intercom WL1 PN 1-2.

Remarks

The WL1 PN 1-2 was a commercial and licence free to purchase consumer 'wireless' intercom system operating via AC mains. It was developed, made and marketed from 1985 onward by VEB Funkwerk Kölleda in the GDR. Special blocking filters TFS 1 were sold separately which had to be mounted at the input of each AC mains group. Without this filter it was not legal to use the intercom. A few years after the introduction it was found that it was possible to overhear channels 2 and 3 (72 and 88.7kHz) from TF-B tx (2A) AC mains bugs 33601 and 33603 (see Chapter 165) on a WL1. In an official information letter from MfS Abt. 26/4, August 1988, to all Abt. 26 branches it was advised to be careful: *'..jedoch mit dem Betrieb auch ohne Frequenzsperrern gerechnet werden!..'* (English: *'...however, operation without a blocking filter must be taken into account..')*

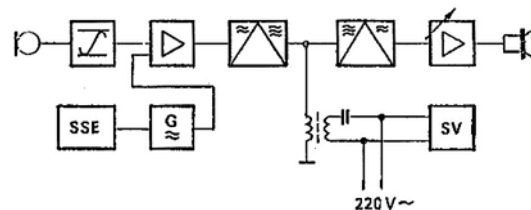

Block circuit diagram of AC mains intercom WL1.

SV= Stromversorgung (Power supply)

SSE= Sensor und Steuerelectronik (Sensor/control electronics.)

G= Generator (Oscillator)

DATA SUMMARY

Organisation: Commercial consumer product.**Design/manufacturer:** VEB Funkwerk Kölleda.**Year of Introduction:** 1985.**Purpose:** Wireless intercom operating on AC mains.**Number of users:** 2-4.**Carrier frequency:** 131kHz.**Modulation:** FM.**Frequency deviation:** ± 4kHz.**Frequency response:** 0.4-4kHz.**Power:** 220V AC mains; ≤ 4W.**Size (cm):** Height 7.1, length 19.8, width 11.**Weight:** 630g.